



PARSETT®

2025

CATALOG

ZHUHAI PARSETT GOLF
PRODUCTS COMPANY LIMITED



PROFESSIONAL SUPPLIER IN GOLF INDUSTRY

PARSETT brand is at the forefront of the golf products supply industry having combined substantial expertise with the finest manufacturing of a diverse range of golf course and driving range supplies.

PARSETT has tremendous support from our own independent manufacturing facilities supplemented by additional relationships with other manufacturers in China providing leading edge technology.

With an unparalleled 17 more years of extensive experience in design, developing and manufacturing golf industry products, we are able to identify the needs of our customers and accommodate them expertly. With an emphasis on customer satisfaction, we hope to provide you with everything you need within the golf industry!



ZHUHAI PARSETT GOLF PRODUCTS COMPANY LIMITED

Building 1, No.12, Jishan Village Industrial Road, Tangjiawan Town, High-tech zone,
Zhuhai City-519080, Guangdong Province, China
Website: www.parsett.com

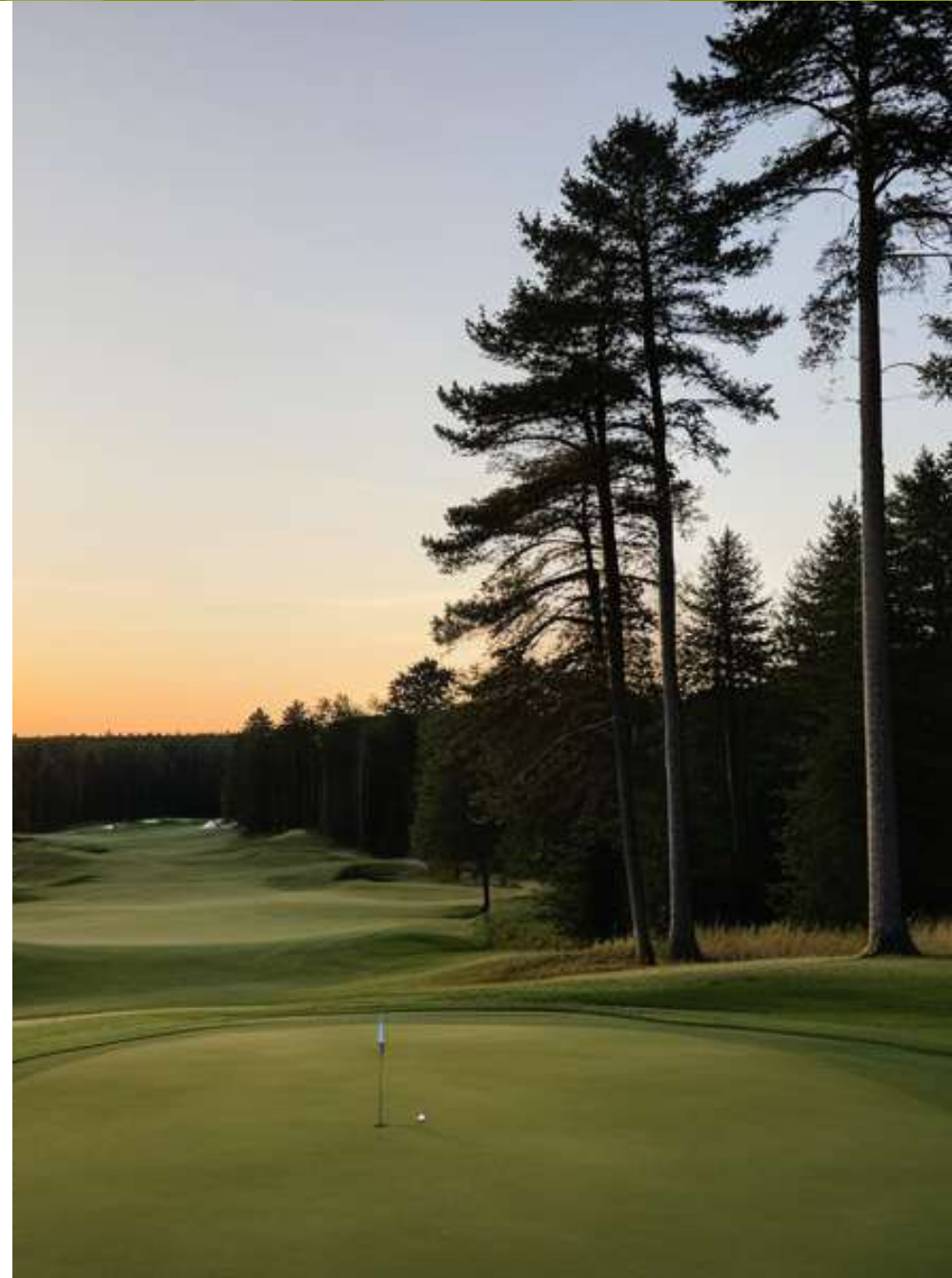

TABLE OF CONTENTS

DRIVING RANGE EQUIPMENTS & SUPPLIES

- 2-3 Recycled Tee Dividers & Ball Crates
- 4 Recycled Bag Stands
- 5-6 Easel Signs & Club Washers
- 7-8 Ball Pickers & Range Ball Washer
- 9-10 Range Mats & Ball Baskets
- 11 Range Ball & Range Ball Containers
- 12 Rubber Tees, Ball Trays & Ball Stackers
- 13 Stainless Steel Tee Dividers
- 14 Range Banners & Range Markers
- 15 Practice Nets
- 16 Practice Green Flagsticks
- 17 Practice Green Cups & Flags

RECYCLED PLASTIC PRODUCTS

- 18 Two-tone Recycled Product Collections
- 19-21 Podiums
- 22 Spike Air Cleaners
- 22 Stainless Steel Air Cleaners
- 23 Bag Racks
- 24 Benches & Chairs
- 25 Water Cooler Enclosures
- 26-31 Trash Containers
- 32 Small Divot Mix Boxes
- 33 Divot Mix Containers
- 34 Sand Divot Bottle, Bottle Racks
- 34 Bottle Containers
- 35-36 Trash & Divot Mix Box Stations
- 37 Club & Umbrella Racks

TEE PRODUCTS

- 38 Ball Washers, Ball Washer Consoles
- 39-40 Waste Mate Trash Bin & Parts
- 41 Ball Washer Composite & shoe Cleaners
- 42 Broken Tee Caddy & Scorecard Caddy
- 43-47 Tee Markers & Tee Dock Distance Marker.

COURSE MARKINGS

- 48-51 Recycled Product Signs with Spike
- 52-53 Recycled Product Signs on Post
- 54 Frame Signs
- 55 Aluminium Decorative Post Signs
- 56-57 Tee Signs
- 58-60 Fairway Distance Signs
- 61 OB & Hazard Markers
- 62 Fairway Posts, Mult-Purpose Markers
- 62 Fencing.
- 63 Rope & Rope Sticks
- 64 Long Drive & NTP Markers
- 65 Club & Umbrella Racks

GREEN PRODUCTS

- 66-67 Green Flags
- 68-71 Flagsticks
- 72 Green Cups

GREEN TOOLS

- 73-74 Hole Cutters
- 75 Green Speedmeter, Cup Setter
- 75 Cup Ring, Cup Puller

BUNKER RAKES

- 76-77 Bunker Rakes

MAINTENANCE TOOLS

- 78 Safety Net, Dew-whipper, Dew Brush
- 79 Drag Brush, Drag Mat, Levelawns
- 80 Turf Plugger, Turf Repairer, Hand operated Aerators, Soil Sampler
- 81 Roller Squeegee, Landscape Rake

ACCESSORIES

- 82 Caddy Goods & Accessories





Just one Look...

Outfitted with our new developed recycled products, a line of premium, high-end furnishings and accessories, your practice facility will be looked so good. The symmetry in a row of tailored Tee dividers and bag stands with matching amenities would give even the most discerning guest pause.

DRIVING RANGE EQUIPMENT & SUPPLIES





[HN-CRD]



[HN-SRD]



[HN-SRDM]

RANGE DIVIDERS

- These dividers are totally made from durable recycled plastic, built to last and designed to enhance the beauty of your driving range.
- Other color or color combinations are available, call to discuss custom options.

CLASSIC RANGE DIVIDER

- This divider will add a class look to your Driving Range.
- 60" W x 28" H (152cm W x 71cm H)

Order information:

HN-CRD Classic Tee Divider

SPONSOR RANGE DIVIDERS

- This divider has a large space for sponsor LOGO, or message in the middle.
- A convex mirror can be easily installed in the top upon you request.
- 64" W x 23" H (163cm W x 58cm H)

Order information:

HN-SRD Sponsor Tee Divider

HN-SRDM Sponsor Divider with Mirror



LOW-PROFILE TEE DIVIDERS

- These dividers are totally made from durable recycled plastic, built to last and designed to enhance the beauty of your driving range.
- Two spikes on the underside to hold in position.
- 48" (120cm) width.



Order information:

- MS-ETD** Elegant Tee Divider
48" W x 3" D x 5" H (120 x 8 x 13cm)
- MS-TTD** Triangular Tee Divider
48" W x 5" D x 4" H (120 x 13 x 10cm)
- 76-UTD** Upright-narrow Tee Divider
48" W x 1.5" D x 3" H (120 x 4 x 8cm)
- 76-FTD** Flat-narrow Tee Divider
48" W x 3" D x 1.5" H (120 x 8 x 4cm)

RANGE BALL CRATES

- Made out of recycled plastic slats.
- Rustproof, fade-resistant and maintenance free.
- Can be neatly stacked together.
- A little angled interior to make range ball distribute from the front slot.
- Two size available, the big size (Large) holds up to 300 balls, and the small size (Small) holds up to 150 balls.
- Your club's logo can be added upon request.
- Available in Brown, Green and Black, please specify color when ordering.

Order information:

- 96-RBCL** Range Ball Crate-Large
Capacity: 300 Golf Balls (approx)
Dimension: 20"W x 13"D x 9"H (50 x 33 x 23cm)
- 96-RBCS** Range Ball Crate-Small
Capacity: 150 Golf Balls (approx)
Dimension: 13"W x 10"D x 9"H (33 x 25 x 23cm)



[96-RBCL]



[HN-RTDM]

RANGE TEE DIVIDER

- These dividers are totally made from durable recycled plastic, built to last and designed to enhance the beauty of your driving range.
- Two spikes on the underside to hold in position.
- 32" W x 22.5" H (81cm x 57cm).

Order information:

- HN-RTD** Range Tee Divider
- HN-RTDM** Range Tee Divider with Mirror

RECYCLED PLASTIC BAG STAND

- Constructed from durable and maintenance free recycled plastic.
- Available in Brown, Green and Black.
- Two tone and custom top are also available. Please contact us to create your very own.

BAG STAND OPTIONS:



[25-FBS]



[19-FBS]



[38-SBR]



[15-SBR]

FOLDING BAG STANDS

Folds up for easy storage.
Free of charge for club grooves and amenity tray option.

Order information:

25-FBS	Folding Bag Stand	20"W x 19"D x 29" H	(51 x 48 x 74 cm)
19-FBS	Folding Bag Stand	23"W x 19"D x 28" H	(59 x 53 x 71 cm)

STABLE BAG RACKS

Some assembly required.

Order information:

38-SBR	Stable Bag Rack	17"W x 22.5"D x 30"H	(43 x 57 x 76 cm)
15-SBR	Stable Bag Rack	16"W x 20"D x 32"H	(41 x 50 x 81 cm)



EASEL SIGNS

- Made of durable recycled plastic, please specify color or color combinations when ordering.
- Range yardage signs come with aluminium tracks available in 2" or 3.5" high, and interchangeable numbers can be supplied accordingly at extra cost.
- Easel clock feature 18" clocks with built-in temperature and humidity meter.
- Dimensions: 24" w x 38" H (folded) (61 cm x 97 cm)
- Custom logo available.



[LN-2T]

INTERCHANGEABLE NUMBERS

2"(5cm) High Number.
3"(8cm) High Number.

Order information:
LN-2S 2" Single
LN-2T 2" Set of 10 (0-9)
LN-3S 3" Single
LN-3T 3" Set of 10 (0-9)



[31518]

18 Inch CLOCK

18"(46cm) Weather Proof Clock.
Order information:
31518 18" Clock



[HC-ESB]

EASEL SIGNS-BLACKBOARD

Custom message.

Order information:
HC-ESB Easel Sign-Blackboard



[HC-ESI]

EASEL SIGNS-INFO BOARD

Custom message.

Order information:
HC-ESI Easel Sign-Info board



[HN-ESR]

EASEL SIGNS-RANGE

Order information:
HN-ESR Easel Sign-Range



[HD-ESC]

EASEL SIGNS-CLOCK

Order information:
HD-ESC Easel Sign-18" Clock



A-FRAME SIGNS

- Made using durable green-beige laminated plastic.
- These A-frame Signs can be single sided or double sided .
- Range yardage signs come with aluminium tracks available in 2" or 3.5"high, and interchangeable numbers can be supplied accordingly at extra cost.
- Custom logo available.



[31511]

31511 11" (28cm)Clock



[L1-AC11]

A-FRAME SIGNS-CLOCK

Small size: 16"x23" (41*58cm)
Clock Dia.: 11" (28cm)

Order information:

L1-AC11 A-Frame Sign-11"Clock

Medium size: 22"x32" (56*81cm)
Clock Dia.: 18" (46cm)

Order information:

L1-AC18 A-Frame Sign-18"Clock



[L1-ARM]

A-FRAME SIGNS-RANGE

Medium size: 22"x32" (56*81cm)

Order information:

L1-ARM A-Frame Sign-Range



[HC-SCC]

SQUARE CLUB CLEANER

- Come with club cleaning liner and brushes.
- Two-tone color construction. Please specify color or color combination.
- 17"Wx17"Dx20"H(43 x 43 x 51 cm)

Order information:

HC-SCC Square Club Cleaner

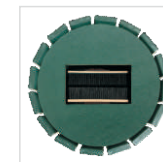

[65-RCC]

ROUND CLUB CLEANER

- Come with club cleaning liner and brushes.
- Ideal for range and Par 3s.
- Size: 16"Dia.x21"H (40X53cm)

Order information:

65-RCC Round Club Cleaner



[MS-RCW]

CLUB WASHER

- Includes a 5 gallon (20liter) pail, hand brush, hooks for hanging tee towels.
- Angled support for bracing club while scrubbing.

Order information:

MS-RCW Club Washer



[96-AC11]

A-FRAME SIGNS-CLOCK

- Made With recycled plastic slats, available in green, brown and black colors.
- 18"x26" (46*66cm), 11"Clock.

Order information:

96-AC11 A-Frame Clock- 11" Clock

RANGE PICKERS

- Conform to any golf ground terrain and designed to minimize damage to turf and range balls.
- Each picker frame and draw bar are powder coated finish to resist rust and corrosion.
- Most durable and flexible composite plastic disc will not break, crack or chip.

RANGE PICKER III

Manufactured specifically for rough, uneven ranges with steep sides and bare spots. Push Bar and mounting bracket included. Can be easily increased to a five gang ball picker.

- Picking Width: 9'(274cm)
- Ball Capacity: 2100 Balls

Order information:
2114 Range picker III



[2114]

RANGE PICKER V

Designed for medium to heavy volume range operations. Push bar and mounting bracket included.

- Picking width: 15'(457cm)
- Ball capacity: 3500balls

Order information:
2115 Range picker V



[2115]

A-FRAME

- Complete with one coupler and mounting bracket.
- A-Frame sold separately.
- Fit Range Picker I and Range Picker II

Order information:
21121 A-FRAME (78"long)

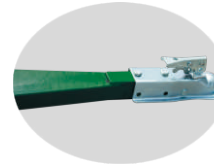

A-Frame Sold Separately

[21121]

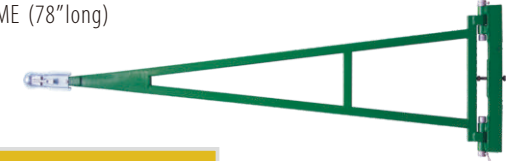

RANGE PICKER I

Designed for lighter ball picking jobs and those hard to reach areas. Can be pushed or pulled.

- Picking width: 5'(152cm)
- Capacity: 1050 Balls

Order information:
2111 Range picker I



[2111]

RANGE PICKER II

Designed specially for budget conscious range owners who want to utilize an electric cart for picking their range.

- Picking width: 7'(210cm)
- Capacity: 1400 Balls

Order information:
2112 Range picker II



[2112]

MINI PICKERS

Use this hand-operated picker for those hard to reach areas or makeshift fairway ranges and practice areas.

Order information:

- 21161** Mini-Picker I
Picking Width: 18" (45cm)
Capacity: 350 balls
- 21162** Mini-Picker II
Picking Width: 24" (60cm)
Capacity: 500 balls
- 21162** Mini-Picker I
Picking Width: 36" (91cm)
Capacity: 700 balls

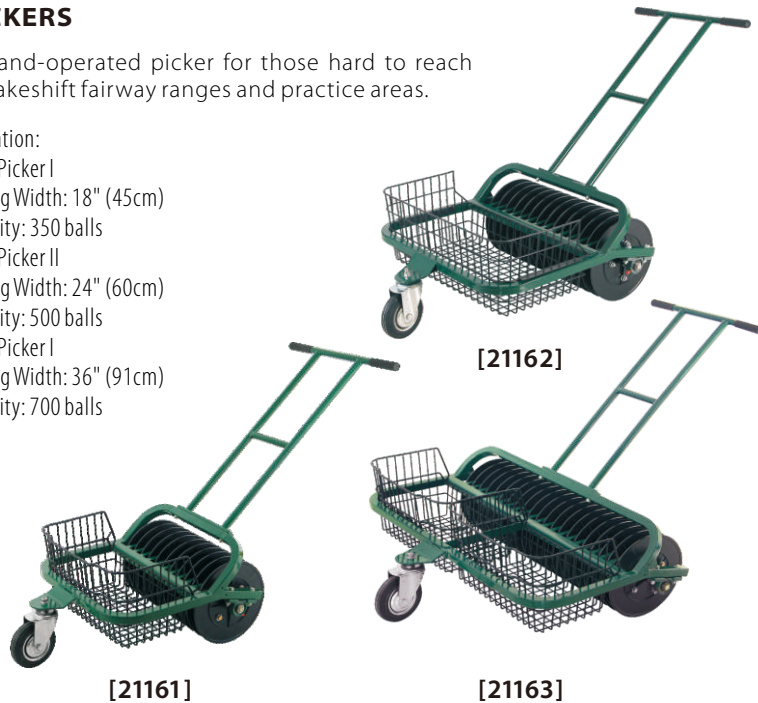

REPLACEMENT BASKETS

Made from heavy gauge steel wire, vinyl-coated black finish.

Order information:

- 211731** Replacement basket
(Fit 2111,2112,2114, 2115,
21161,21163)
- 211732** Replacement basket (Fit 21162 only)



REPLACEMENT DISC

Strong and flexible composite plastic discs, built to endure the toughest picking conditions.

Order information:

- 21171** Replacement disc

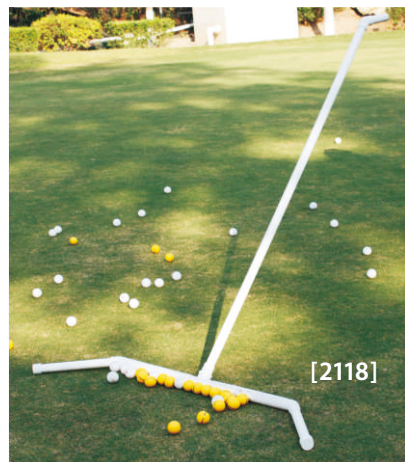

BALL SWEEPER

This light weight tool is a fast and efficient aid to remove golf balls from your practice green during lesson time. Made from durable PVC tube and with a roller action.

Size: 3.5"X5'(106cm x 152cm)

Order information:

- 2118** Ball sweeper



RANGE BALL WASHER

- All stainless steel and plastic construction will assure that there will be no rust or corrosion.
- The exclusive "Spiral Flute Brush" design delivers the most complete cleaning possible.
- Integrated ball gate demonstrate convenient and easy to use.
- Single-swinging open lid make the cleaning job more efficiency.
- Less friction ensure minimum damage to balls.

Power: 380V/50Hz, 750W,
Size: 5-1/3"W X 2-1/10"D X 2-4/5"H
(163cmWX64cmDX85cmH)

Order information:

- 2121** Range Ball Washer
- 2120** Brush Drum

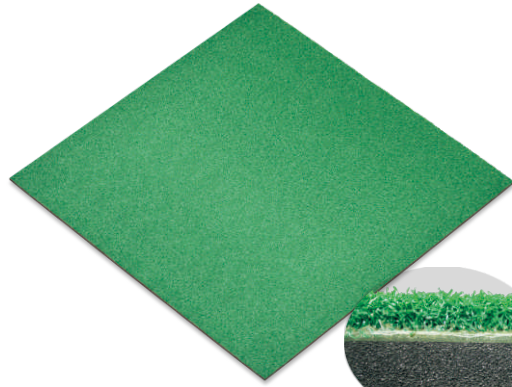

[2211A]

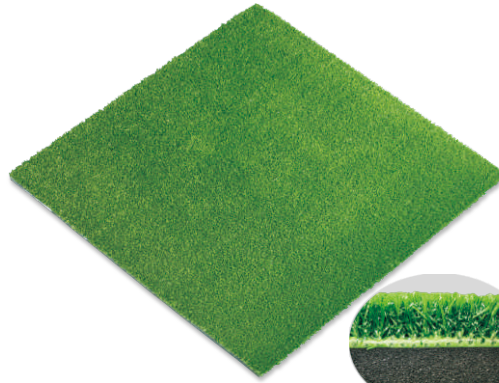

[2212A]

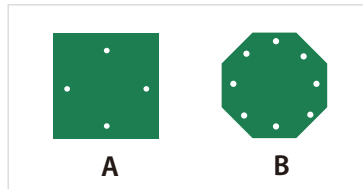

A

B

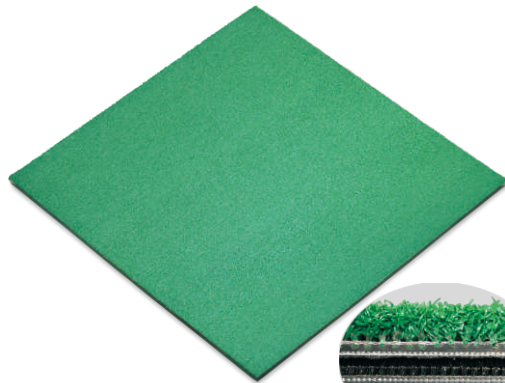

[2216A]

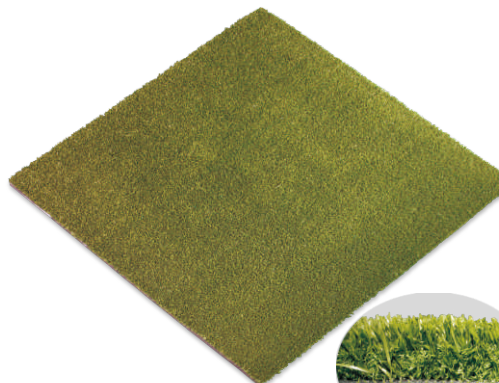
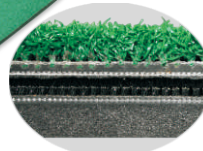

[2214A]



SHOCK-SAVER MAT

Constructed from high quality nylon turf and resilient foam padding. The foam padding can be standard 15mm thick, both soft enough to absorb impact and strong enough to avoid distortion.
Size: 59"X59"X1-1/5" (150xcmx3cm), (1.5cm foam)

Order information:

2211A Shock-Saver Mat Standard-Square

2211B Shock-Saver Mat Standard-Octagon

DUAL-GRASS MAT

The Dual-Grass Mat combines both straight and curled fibre. The straight fibre keeps the ball elevated for less clubhead resistance and the curled fibre provides cushioning and grip for player comfort and confidence.

The foam padding can be standard 15mm or alternative 20mm thick.
Size: 59"X59"X1-1/5" (150cmx150cmx30mm), (15mm foam)

Order information:

2212A Dual-Grass Mat Standard-Square

2212B Dual-Grass Mat Standard-Octagon

DELUXE ROUGH AREA MAT

Designed to simulate play from heavier or longer grass by using a longer fibre. This provides an increased resistance at impact for both the ball and club head and encourages the player to connect with the ball first and accelerate the club head through the impact zone.
Size: 59"X59"X1-9/10" (150cmx150cmx48mm), (15mm foam)

Order information:

2214A DELUXE ROUGH AREA MAT-square

2214B DELUXE ROUGH AREA MAT-octagon

MULTI-FLEX MAT

Featuring shock absorbing layer of three dimensional air cushion. The spring-like layer creates an incredibly soft feel and providing extra protection to golfer's wrists.
Size: 59"X59"X1-3/8" (150cmx150cmx35mm)

Order information:

2216A MULTI-FLEX MAT-square

2216B MULTI-FLEX MAT-octagon

TEE-UP MAT

By constructing the Tee Up Mat with a curled thick fibre and foam padding, this unique design allows the player to use a normal wooden tee to replicate actual play and vary tee heights during a practice session. The player is encouraged to stay on the Mat for the whole practice session rather than seeking out and damaging a grassed area.

Order information:

2217 Tee-up mat Square
59"x59"x2"
(150 x 150 x 5cm)

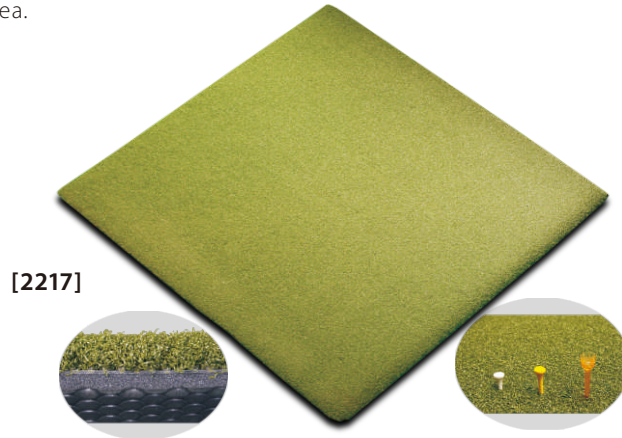

[2217]

TEACHING MAT

This teaching/practice mat come with whitestripe and center indicator which permanently imbedded in the mat, assist golfer to have the correct swing and stance.

Constructed from high quality nylon turf and resilient foam padding.

Order information:

2200 Teaching Mat Square
59"x59"x1-3/8"
(150x150x3.5cm)



[2200]



[2321]

STEEL BALL BASKETS

Made from heavy guage steel wire, galvanized and vinly-coated black. Available in two sizes.

Item NO.	Bottom (cm)	Top (cm)	Height (cm)	Capacity (balls)
23213	14	21	16	50-55
23216	14	26	25	100-110



[2322]

PLASTIC BALL BASKETS

High quality material provides better durability. Two sizes available for your choice.

Item NO.	Bottom (cm)	Top (cm)	Height (cm)	Capacity (balls)
23222	13	23	22	70-75
23223	14	25	25	100-110

RANGE BALL STACKING BOX

Made of durable plastic, This box can be stacked up in layers to create a clean and organized tee line while increasing labor efficiency. Ball capability: 30pcs balls

Order information:

2323A Yellow
2323B Dark green



[2323]



[25-BSB]

RANGE BALL STORAGE BOX

Made using 2.5cm thick recycled plastic slats, this heavy-duty range ball storage box is extremely durable, can be left outside all day and night, even in the harshest conditions. A folding open lid make it extremely convenient to refill your range baskets.

Available in Back, Green and Brown, Please specify color when ordering.
37" W x 26"D x 26"H (94*67*66cm)
Custom size also available upon request.

Ordering information:
25-BSB Range Ball Storage Box

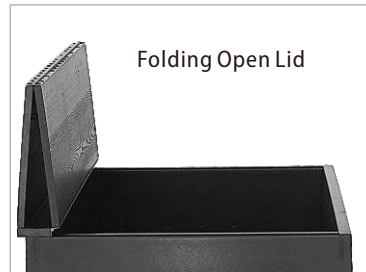

Folding Open Lid



[96-BSB]

RANGE BALL STORAGE BOX

- This unit is perfect for storage of golf balls up to 5000pcs.
- Dual top lids open easy access.
- Dimension: 38.5"Wx26.75"Dx29"H (98x68x74cm)
- Available in Back, Green and Brown, Please specify color when ordering.

Ordering information:
96-BSB Range Ball Storage Box

STANDARD RANGE BALL



Customized LOGO is available upon request



1-PC STANDARD RANGE BALL

Ordering information:
22211A 1 pc Standard Range Ball- White
22211B 1 pc Standard Range Ball- Yellow

2-PC STANDARD RANGE BALL

Ordering information:
22221A 2 pc Standard Range Ball- White
22221B 2 pc Standard Range Ball- Yellow

FLOATER GOLF BALL

Ordering information:
2224A Floater Range Ball- White
2224B Floater Range Ball- Yellow

CUSTOM GOLF BALL

Please contact us to customized your golf ball with imprinting logo on the ball surface for promotion, gift use, logo can be imprinted up to six colors.

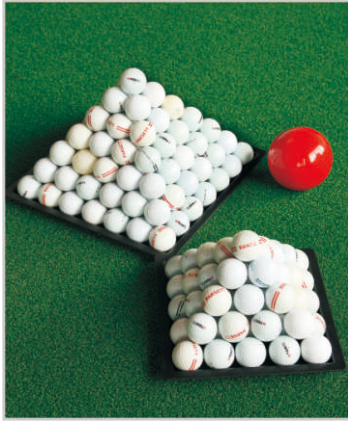

PYRAMID STACKER

Simply place the Pyramid Filler over a Pyramid tray and pour ! In several seconds you have a perfectly formed pyramid. Each tray holds an exact count every time. The pyramid adds a quality appearance to any driving range.



[2370]

PLASTIC PYRAMID TRAYS

Made from high impact plastic.

Order information:
23701 55 Ball Plastic Tray
23703 140 Ball Plastic Tray



[2371]

PYRAMID STACKER

Constructed from stainless steel.

Order information:
23711 55 Ball Pyramid Stacker
23713 140 Ball Pyramid Stacker



[2233]



[2231]



[2325]



[2328]

RUBBER TEE HOLDERS

These rubber tee holders allow you to use your regular wooden tees in any mat rather than the rubber tees that are not adjustable and not realistic.

Order information:
22331 1-1/2"(38mm)
22332 1-3/4"(45mm)
22333 2"(51mm)

RUBBER TEES

Made from high quality rubber which is both soft and durable.

Order information:
22311 1-1/2"(38mm) Rubber Tee
22312 1-3/4"(45mm) Rubber Tee
22313 2"(51mm) Rubber Tee
22314 2-1/4"(57mm) Rubber Tee
22315 2-1/2"(64mm) Rubber Tee
22316 2-3/4"(70mm) Rubber Tee
22317 3"(76mm) Rubber Tee

PLASTIC BALL TRAY

Made of PE material, available in dark green. 24"W x 13-1/2"D x 4"H (61x 34 x 10cm)

Order information:
2325 Plastic Ball Tray

RUBBER BALL TRAY

This ball tray can hold more than 100pcs golf balls. It's made of recycled crumb rubber and has a contoured edge to the mats allowing you to pull balls from the tray to the mat seamlessly. Absorbs noise of golf balls, won't move, won't crack. Weight: 9kg(19.8 lb)

Order information:
2328 Rubber Ball Tray

HEAVY DUTY TEE DIVIDERS

- Heavy duty steel pipe and bar construction, finished with powder coated to prevent rust.
- Steel mesh welded to the frame, formed with the body as one piece to withstand strong wind.
- Tee number can be imprinted or stuck with number decals.
- Canvas banner tightened to the frame with plastic snap.
- Bag stand can be easily attached.
- Size: 60"Wx28-3/4"H (152cm x 73cm)

Order information:

- 2241** Steel Mesh Tee Divider
- 2242** Canvas Tee Divider
- 22411** Optional Bag Stand.

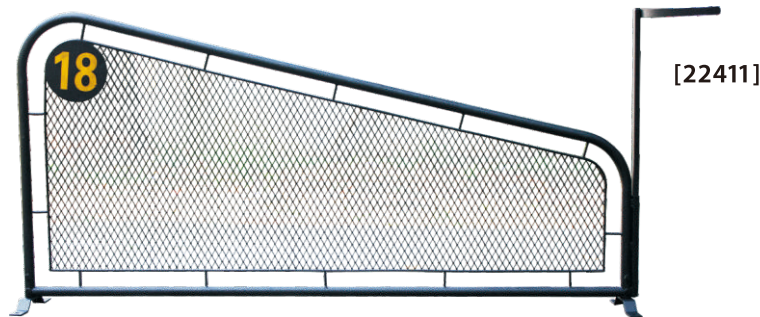

[2241]

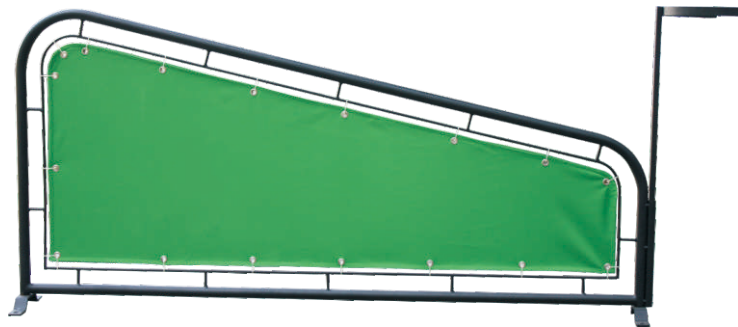

[2242]

STAINLESS STEEL TEE DIVIDERS

- Stainless steel tubing construction frame tightened with canvas cloth, your logo/company name can be imprinted on the cloth or round steel plate.
- Strong plastic mirror shows player address and impact position.

Order information:

- 2243** Stainless Steel Tee Divider
Size: 60" x 26" (152 x 66cm)
- 2244** Stainless Steel Tee Divider with Mirror
Size: 60" x 27" (152 x 69cm)
- 2245** Stainless Steel Tee Divider with Mirror
Size: 60" x 20" (152 x 51cm)



RANGE BANNERS

Banner material: The new "Textilene fabric" mesh material makes the banner most durable, high strength and excellent weather resistance. Available color: Yellow.

Metal Frame: Complete aluminium tubing(7/8" Dia. 2.2cm) and fittings are rust-free and strong enough to withstand high impact from the ball.

Size: 48"X24"(122cmX61cm) Horizontal

Order information: (Banner Frame kit not included)

- 24111 Range Banners Horizontal 50
- 24112 Range Banners Horizontal 100
- 24113 Range Banners Horizontal 150
- 24114 Range Banners Horizontal 200
- 24115 Range Banners Horizontal 250
- 2411C Custom Banners

24117 Range banner frame kit

[24117]



[2411]



[2413]



[2415]

RANGE MARKERS

- Constructed from two-tone HDPE laminated plastic.
- Engraved white numbers on green.
- Come with recycled plastic post.

Horizontal Rang

Size: 31"WX24"H (78x61cm)

Order information:

- 24131 Horizontal Range marker 50
- 24132 Horizontal Range marker 100
- 24133 Horizontal Range marker 150
- 24134 Horizontal Range marker 200
- 24135 Horizontal Range marker 250

Oval Rang Markers

Size: 48"WX30"H(122x76cm)

Order information:

- 24151 Oval Range marker 50
- 24152 Oval Range marker 100
- 24153 Oval Range marker 150
- 24154 Oval Range marker 200
- 24155 Oval Range marker 250

Vertical Rang Markers

Size: 12"WX48"H(30x122cm)

Order information:

- 24141 Vertical Range marker 50
- 24142 Vertical Range marker 100
- 24143 Vertical Range marker 150
- 24144 Vertical Range marker 200
- 24145 Vertical Range marker 250



[2414]



Available color combinations:

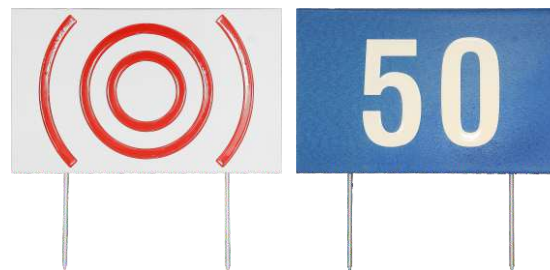

CHIPPING TARGETS

- Great for short game practice.
- High visible and high impact range.
- 1" (2.5cm) thick recycled plastic sign with two stainless steel spikes, extremely durable.
- 5 color combinations for your choice.
- Sign dimensions: 20" x 12" (50 x 30cm)

Order information:

25-CT Chipping Targets
(Please specify color combination when ordering.)

ADJUSTABLE HIPPING NETS

Powder coated steel frame with PE netting sewn into the frame
Dia.17"x17"-3/4" H (43 x 45cm)

Order information:

24511 Adjustable Chipping Net



[24511]

STAINLESS STEEL CHIPPING NETS

Stainless steel frame with PE netting sewn into the frame
Dia.22-4/5"x18"H (58 x 46cm)

Order information:

24512 Stainless Steel Chipping Net



[24512]

TARGET NETS

Powder coated steel frame with vinyl netting sewn to the frame. These target nets are easily assembled and can be used either as chipping nets or placed on the range as target nets.

Order information:

24521 Target Net 1m Dia.

24534 Target Net 1.2m Dia. With Accent Circle

Order information:

24522 Target Net 2m Dia.

24523 Target Net 3m Dia.



[24521]



[24534]



[24522]



[24523]

PRACTICE GREEN FLAGSTICKS

Fiberglass rod and plastic ferrule. Come with a ball nut Dia.4cm
Size: 34"(86cm) tall, 1/2" (1.3cm) diameter rod

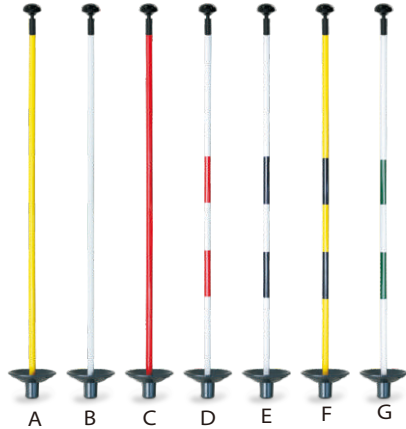

[2432]

Order information: (with plastic base)

- 2432A Solid Yellow
- 2432B Solid White
- 2432C Solid Red
- 2432D White/red
- 2432E White/black
- 2432F Yellow/black
- 2432G White/green



Order information: (with metal base)

- 2432MA Solid Yellow
- 2432MB Solid White
- 2432MC Solid Red
- 2432MD White/red
- 2432ME White/black
- 2432MF Yellow/black
- 2432MG White/green



DELUXE PRACTICE GREEN FLAGSTICKS

Deluxe Practice Green Flagsticks feature an extra thick fiberglass tube in the center section, for greater strength, visibility and wind resistance. 1/2" (1.3cm) diameter and 1" (2.5cm) diameter extra thick section. 39" (99cm) tall.



[2433]

Order information: (with plastic base)

- 2433A Solid White
- 2433B Solid Yellow
- 2433C White/red
- 2433D White/black
- 2433E White/green
- 2433F Yellow/black



Order information: (with metal base)

- 2433MA Solid White
- 2433MB Solid Yellow
- 2433MC White/red
- 2433MD White/black
- 2433ME White/green
- 2433MF Yellow/black



[2431]



[2430M]



[2435W] [2435A] [2435B]

PRACTICE GREEN MARKERS

Fiberglass rod, plastic head and ferrule. Each head includes number decals on both sides. Please specify hole number when ordering. Available in red/white and green/white colors. The marker can be personalized with decals feature club logo. Also available without number.
36-3/5" (93cm) tall, 8/25" (0.8cm) diameter rod.

Order information:

- 24311A Red/white (without number)
- 24311B Green/white (without number)

WOODEN PRACTICE GREEN FLAGSTICKS/MARKS

- Made of strong hardwood, finished with natural teak oil.
- Come with New Zinc alloy base for added handsome look and durability.
- 0.75 inch (2cm) rod tapered at both ends, 34" (84cm) tall.

Order information:

- 2434MF Wooden Practice Green Flagstick
- 2434MM Wooden Practice Green Mark



[2434MF] [2434MM]

CUPLESS PRACTICE GREEN FLAGSTICKS/MARKS

Order information:

- 2435W Cupless Wood Practice Green Marker
0.75 inch (2cm) wood rod tapered at both ends, 34" (84cm) tall.
- 2435A Solid White Fiberglass Practice Green Marker
0.5 inch (1cm) fiberglass rod, 32" (81cm) tall.
- 2435B Solid Yellow Fiberglass Practice Green Marker

PLASTIC CUPS

Durable bright white plastic featuring minimum taper.

Order information:

2421 4"(10.2cm) practice cup

3333 6"(15.2cm) Putting cup



[2421]



[3333]



[2441]

PRACTICE GREEN SOLID FLAGS

High quality nylon material, 9"x 6" (23cm x 15cm)

Order information:

2441A Solid Red

2441B Solid Yellow

2441C Solid Blue

2441D Solid White

2441E Solid Gold

2441F Solid Green



[2442]

PRACTICE GREEN CHECKERED FLAGS

High quality nylon material, Size: 9"x6" (23cmX15cm)

Order information:

2442A Yellow/black

2442B White/ green

2442C White/red

2442D White/black

2442E Gold/black

2442F White/Blue



[2443]

PRACTICE GREEN NUMBER FLAGS

High quality nylon material, 9"x 6" (23cm x 15cm)

Order information:

24431A Red 1-9

24431B Yellow 1-9

24431C Blue 1-9

24431D White 1-9

24432A Red 10-18

24432B Yellow 10-18

24432C Blue 10-18

24432D White 10-18

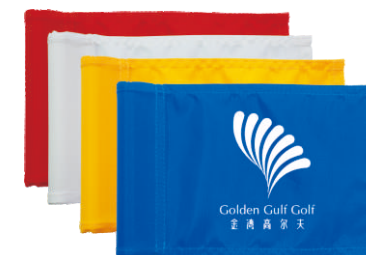

[2444]

CUSTOM PRACTICE GREEN FLAGS

High quality nylon material. Your custom logo can be screen printed or embroidered on the flags.

Order information:

24441 Custom screen printed



24442 Custom embroidered

DUAL-COLOR SELECTION

Parsett golf is proud to introduce our new Dual-color products line: A full selection of products made from 100% recycled plastic in two tone color, built to last and designed to enhance the beauty of your course.





Available Panel colors

		
GREEN	BLACK	BROWN

AVAILABLE PANEL & TRIM COLORS

You can choose your color combinations to create your own coordinated style

Available Trim colors

		
GREEN	BLACK	BROWN

PODIUMS

Constructed from 100% recycled plastic, these fantastic looking podium will give customs years of use with almost no maintenance required.

Many colors or color combinations are available, custom logo also available upon request.

Please specify color or color combinations when ordering.



[HS-FTPS]



[Back View]

FLATTOP PODIUMS

Order Information:

HS-FTPS Flat Top Podium (Small)
26.5"W x 21"D x 44"H
(67 x 53 x 112cm)

HS-FTPM Flat Top Podium (medium)
39"W x 21"D x 44"H
(99 x 53 x 112cm)

HS-FTPL Flat Top Podium (large)
76"W x 21"D x 44"H
(193 x 53 x 112cm)



[HC-STPS]



[Back View]

SLOPING TOP PODIUMS

Order Information:

HC-STPS Sloping Top Podium (Small) 22"W x 22"D x 48"H (56 x 56 x 122cm)

HD-STPM Sloping Top Podium (Medium) 39"W x 22"D x 48"H (99 x 56 x 122cm)

HD-STPL Sloping Top Podium (large) 61"W x 22"D x 48"H (155 x 56 x 122cm)



[HD-STPL]



[Back View]



Central hole for umbrella

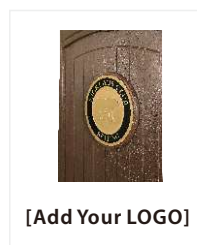

[Add Your LOGO]



[HS-FTPL]

PODIUMS

Constructed from 100% recycled plastic, these fantastic looking podium will give customs years of use with almost no maintenance required. Many colors or color combinations are available, custom logo also available upon request.

Please specify color or color combinations when ordering.

DOUBLE WORKTOP PODIUMS

Order Information:

HS-DTPM Double worktop Podium (medium)
39"W x 20"D x 47"H (99 x 50 x 119cm)

HS-DTPL Double Worktop Podium (large)
59"W x 20"D x 47"H (150 x 50 x 119cm)



[Back View]



[HS-DTPL]



[HC-SPKC]



[HN-SCB]



[MS-TB1]

STARTER PODIUM KIT

Order Information:

HC-STPS Sloping Top Podium
22"W x 22"D x 48H (56 x 56 x 122cm)

HN-SCB Scorecard box
19"W x 14"D x 11"H (48 x 35 x 28cm)

MS-TB1 Table:
22"W x 22"D x 20"H (56 x 56 x 50cm)

HC-SPKC Complete Kit

DOUBLE WORKTOP PODIUM

- Constructed from 100% recycled plastic, maintenance free.
- The double work top can be made in two different sizes, one is 122cm wide, and another is 99cm wide.
- Come with a big desk drawer for storage of documents , radios an etc.
- Please specify color or color combinations.

Order information:

MS-DTP99 Double Worktop Podium 39"W x 22"D x 45"H (99 x 56 x 114cm)
MS-DTP122 Double Worktop Podium 48"W x 22"D x 45"H (122 x 56 x 114cm)



[MS-DTP122]

PORTABLE PODIUM

- This Portable Podium is made from recycled plastic with hinged top and storage underneath. Easily moves to wherever needed.
- Available color option: Green, Brown and Black, Please specify color when ordering.
- 25"W x 18"D x 40"H (63 x 46 x 102cm)

Order information:

MS-PP Portable Podium



[MS-PP]



CADDIE EVALUATION BOX

- This Caddie Evaluation Box is designed for Caddie Master to collect evaluation cards signed by Golfer.
- Made from recycled plastic with lockable hinged top and four separated storage tank underneath. Each storage tank marked on its top with rating symbol or words, such as Excellent, Good, Fair, and Poor separately.
- Available color option: Green, Brown and Black, Please specify color when ordering.
- 22"W x 12"D x 40"H (56 x 30 x 101cm)

Order information:

MS-CEB Caddies Evaluation Box



[MS-CEB]



SPIKE AIR CLEANER

- Completely made of durable recycled plastic.
- Many colors or color combinations available for your choice, please specify color when ordering.
- Utilizes compressed air to blow dirt and grass off shoes.
- Features a easy-removable tray to dump the dirt for a simple.
- Included air wands but compressor not included.



HD-MSAC]

MASTER SPIKE AIR CLEANER

49"Wx21"Wx43"H (124 x 53 x 110cm)

Order information: (Air compressor not included)

HD-MSAC Master Spike Air Cleaner



[HD-KSAC]

KING SPIKE AIR CLEANER

27.5"Wx21"Wx43"H (67 x 53 x 110cm)

Order information: (Air compressor not included)

HD-KSAC King Spike Air Cleaner

STAINLESS STEEL SPIKE AIR CLEANER



[34712]

34712 Jet Cleaner Jr.

46"Lx19-1/2"Wx38"H (116 x 50 x 97cm)



[34711]

34711 Jet Cleaner Pro

94"Lx20-2/3"Wx40"H (240 x 53 x 102cm)



[3472]

3472 Compressed Water Vapor Cleaner

94"Lx20-2/3"Wx40"H (240 x 53 x 102cm)

BAG RACKS

- Constructed completely from durable recycled plastic.
- Many colors or color combinations available for your choice, please specify color when ordering.

Order information: (Some assembly required)

MS-BR3 3-Bag Rack 45"Wx22.5"Wx30"H (115 x 57 x 76cm)

MS-BR5 5-Bag Rack 73.5"Wx22.5"Wx30"H (187 x 57 x 76cm)

MS-BR5D 10-Bag Rack 73.5"Wx40"Wx30"H (187 x 102 x 76cm)



Add your logo

Order information:

HN-BR5 5-Bag Rack 71"Wx20"Wx37"H (180 x 50 x 94cm)

75S-BR5 5-Bag Rack 71"Wx20"Wx33.5"H (180 x 50 x 85cm)



[MS-BR3]



[MS-BR5]



[MS-BR5D]



[75S-BR5]



[HN-BR5]



[23112]

23112 Steel 6-Bag Rack
78"Wx20.5"Dx29.5"H (198 x 52 x 75cm)



[23113]

23113 Steel 12-Bag Rack (Double Sided)
78"Wx43"Dx32"H (198 x 109 x 81cm)



[23161]

23161 Traditional 5-Bag Rack
74"Wx23"Dx30"H (180 x 58 x 76cm)



[23162]

23162 Traditional 10-Bag Rack (Double Sided)
74"Wx44.5"Dx30"H (180 x 113 x 76cm)

BENCHES AND CHAIRS

- Both seat slats and legs are made of recycled plastic.
- Tough, maintenance free and durable.
- Black plastic bolt covers included.
- Assembly required.



Engraved Slats Option

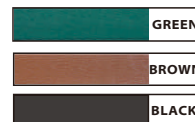

Slat Color Option



[76-HBB152]

HIGH BACK BENCH

Order information:

- 76-HBB122** 4FT(122cm) Bench-2 Legs
- 76-HBB152** 5FT(152cm) Bench-3 Legs
- 76-HBB183** 6FT(183cm) Bench-3 Legs

BACKLESS BENCH

Order information:

- 76-BLB122** 4FT(122cm) Bench-2 Legs
- 76-BLB152** 5FT(152cm) Bench-3 Legs
- 76-BLB183** 6FT(183cm) Bench-3 Legs



[76-BLB152]

DELUXE BACKLESS BENCH

- Constructed 100% from maintenance-free recycled plastic .
- Available in three vivid colors (black, brown and green) and two-tone options. please specify color or color combination when ordering.

Order information:

- HD-BLB152** 5FT(152cm) Bench



[HD-BLB152]

COZY ADIRONDACK CHAIR AND FOOTSTOOL

Order information:

- MS-CAC** Adirondack Chair (Same assembly required)
29"W x 33.5"D x 39.5"H (73x 85 x 100cm)
- MS-FS1** Footstool
19"W x 19"D x 15"H (48x48x38cm)



[MS-FS1]

[MS-CAC]

CASUAL ARM CHAIR AND TABLE

Order information:

- MS-CRC** Casual Arm Chair (Same assembly required)
26.5"W x 28"D x 41"H (67x71x104cm)
- MS-ST1** Side Table 20"W x 13"D x 18.5"H (50x33x47cm)



[MS-ST1]

[MS-CRC]

WATER COOLER AND TRASH STATION

- These front loading water cooler and trash station are creatively design and constructed with a front accommodating table and two cup dispensers which are integrated with the front door for easy of use.
- Can accommodate a 5 Gal. or 10 Gal. water cooler on top (sold separately) and a 16 Gal.(60L) trash liner (included) on the bottom.
- Constructed 100% from maintenance-free recycled plastic , lockable front door .
- Available in threevivid colors (black, brown and green) and two-tone options. please specify color or color combination when ordering.



WATER COOLER AND TRASH STATION

Order information:

MSM-WTS Water Cooler & Trash Station
24"W * 24"D*68.5"H (61* 61*174cm)

HDM-WTS Water Cooler & Trash Station
25"W * 25"D*72"H (64* 64*183cm)



[HDM-WTS]



[MSM-WTS]

POST-MOUNT WATER COOLER ENCLOSURE

- Same construction as Water Cooler and Trash Station but without portion of trash.
- Can be placed on a sturdy platform or mounted on post (sold separately).

Order information:

MSM-PWC Water Cooler Enclosure
24"W * 24"D*33"H (61* 61*84cm)



[MSM-PWC]



[3570]
Cup Dispenser



[3560]
5 gallon (19L) Cooler

COOLER BOX

- Constructed from maintenance free recycled plastic , Come complete with a removable 60L cooler.
- Available in colors (black, brown and green) and two-tone options. please specify color or color combination when ordering.

Order information:

HD-CB6 Cooler Box
31"W * 22"D*33"H (79* 56*84cm)



[HD-CB60]

TRASH CONTAINERS

- Constructed from maintenance free recycled plastic.
- Come with removable plastic inner bucket.
- Front hinged door make removing inner bucket a breeze.
- Capacity options: 60L(16Gal.) & 100L (26Gal.)
- Trash Load options: Top load & Front load.
- Custom logo can be added upon request.
- Available in three vivid colors (black, brown and green) and two-tone options. please specify color or color combination when ordering.



[HD-FTC60D]



[HD-FTC60T]



[HD-FTC60S]

FRONT LOAD TRASH CONTAINERS

Order information:

- HD-FTC60S** Front Load (60L Single)
19"W * 19"D*35"H (49* 49*89cm)
- HD-FTC60D** Front Load (60L Double)
37"W * 19"D*35"H (94* 49*89cm)
- HD-FTC60T** Front Load (60L Triple)
55"W * 19"D*35"H (139* 49*89cm)
- HD-FTC100S** Front Load (100L Single)
22"W * 22"D*40"H (56* 56*101cm)
- HD-FTC100D** Front Load (100L Double)
43"W * 22"D*40"H (109* 56*101cm)
- HD-STC100T** Front Load (100L Triple)
64"W * 22"D*40"H (162* 56*101cm)



Ashtray Option:
Stainless steel ashtrays:



S-ASH1
6-8/9"W x 6-2/5"D x 2-3/5"H
(17.5 x 16.2 x 6.6cm)



S-ASH2
5" Dia x 2"H
(12.5cmDia x 2.5cm)



[HD-TTC60S]



[HD-TTC60D]

TOP LOAD TRASH CONTAINERS

Order information:

- HD-TTC60S** Top Load (60L Single)
19"W * 19"D*30"H (49* 49*76cm)
- HD-TTC60D** Top Load (60L Double)
37"W * 19"D*30"H (94* 49*76cm)
- HD-TTC60T** Top Load (60L Triple)
55"W * 19"D*30"H (139* 49*76cm)
- HD-TTC100S** Top Load (100L Single)
22"W * 22"D*35"H (56* 56*88cm)
- HD-TTC100D** Top Load (100L Double)
43"W * 22"D*35"H (109* 56*88cm)
- HD-TTC100T** Top Load (100L Triple)
64"W * 22"D*35"H (162* 56*88cm)



TRASH CONTAINERS

- Constructed from maintenance free recycled plastic, come with removable plastic inner bucket.
- Front hinged door make removing inner bucket a breeze.
- Capacity options: 60L (16Gal.) & 100L (26Gal.)
- Trash Load options: Top load & Front load.
- Custom logo can be added upon request.
- Available in three vivid colors (black, brown and green) and two-tone options. please specify color or color combination when ordering.

TOP LOAD TRASH CONTAINERS

Order information:

- HN-TTC60S** Top Load (60L Single)
19"W * 19"D*30"H (49* 49*76cm)
- HN-TTC60D** Top Load (60L Double)
37"W * 19"D*30"H (94* 49*76cm)
- HN-TTC60T** Top Load (60L Triple)
55"W * 19"D*30"H (139* 49*76cm)
- HN-TTC100S** Top Load (100L Single)
22"W * 22"D*35"H (56* 56*88cm)
- HN-TTC100D** Top Load (100L Double)
43"W * 22"D*35"H (109* 56*88cm)
- HN-TTC100T** Top Load (100L Triple)
64"W * 22"D*35"H (162* 56*88cm)



[HN-TTC60D]



[HN-TTC60S]



[HN-TTC60T]



[HN-FTC100S]



[HN-FTC100D]

FRONT LOAD TRASH CONTAINERS

Order information:

- HN-FTC60S** Front Load (60L Single)
19"W * 19"D*35"H (49* 49*89cm)
- HN-FTC60D** Front Load (60L Double)
37"W * 19"D*35"H (94* 49*89cm)
- HN-FTC60T** Front Load (60L Triple)
55"W * 19"D*35"H (139* 49*89cm)
- HN-FTC100S** Front Load (100L Single)
22"W * 22"D*40"H (56* 56*101cm)
- HN-FTC100D** Front Load (100L Double)
43"W * 22"D*40"H (109* 56*101cm)
- HN-FTC100T** Front Load (100L Triple)
64"W * 22"D*40"H (162* 56*101cm)



Ashtray Option:
Stainless steel ashtrays:



S-ASH1
6-8/9"W x 6-2/5"D x 2-3/5"H
(17.5 x 16.2 x 6.6cm)



S-ASH2
5" Dia x 2"H
(12.5cmDia x 2.5cm)



TRASH CONTAINERS

- Constructed from maintenance free recycled plastic
- Come with removable plastic inner bucket.
- Front hinged door make removing inner bucket a breeze.
- Capacity options: 60L(16Gal.) & 100L (26Gal.)
- Trash Load options: Top load & Front load.
- Custom logo can be added upon request.
- Available in three vivid colors (black, brown and green) and two-tone options. please specify color or color combination when ordering.



Ashtray Option:
Stainless steel ashtrays:



S-ASH1
6-8/9"W x 6-2/5"D x 2-3/5"H
(17.5 x 16.2 x 6.6cm)



S-ASH2
5" Dia x 2"H
(12.5cmDia x 2.5cm)



[TD-FTC60S]

FRONT LOAD TRASH CONTAINERS

Order information:

TD-FTC60S	Front Load (60L Single)	20"W * 20"D*34"H (51* 51*87cm)
TD-FTC60D	Front Load (60L Double)	38"W * 20"D*37"H (97* 51*87cm)
TD-FTC60T	Front Load (60L Triple)	56"W * 20"D*37"H (141* 51*87cm)
TD-FTC100S	Front Load (100L Single)	23.5"W * 23.5"D*39"H (60* 60*99cm)
TD-FTC100D	Front Load (100L Double)	44"W * 23.5"D*39"H (112* 60*99cm)
TD-FTC100T	Front Load (100L Triple)	65"W * 23.5"D*39"H (165* 60*99cm)



[TD-TTC100S]



[TD-FTC60D]

TOP LOAD TRASH CONTAINERS

Order information:

TD-TTC60S	Top Load (60L Single)	20"W * 20"D*30"H (51* 51*76cm)
TD-TTC60D	Top Load (60L Double)	38"W * 20"D*30"H (96* 51*76cm)
TD-TTC60T	Top Load (60L Triple)	56"W * 20"D*30"H (141* 51*76cm)
TD-TTC100S	Top Load (100L Single)	23.5"W * 23.5"D*34"H (56* 60*87cm)
TD-TTC100D	Top Load (100L Double)	44"W * 23.5"D*34"H (112* 60*87cm)
TD-TTC100T	Top Load (100L Triple)	65"W * 23.5"D*34"H (165* 60*87cm)



[TD-TTC100D]

TRASH CONTAINERS

- Constructed from maintenance free recycled plastic, come with removable plastic inner bucket.
- Front hinged door make removing inner bucket a breeze.
- Plastic inner bucket Capacity : 40L (10Gal.)
- Trash Load options: Side & Front load.
- Custom logo can be added upon request.
- Available in three vivid colors (black, brown and green) and two-tone options. please specify color or color combination when ordering.

SIDE LOAD TRASH CONTAINER

Order information:

PS-STC40 Side Load (40L Single)
19"W * 15"D * 39.5"H
(48*38*100cm)



[PS-STC40]

FRONT LOAD TRASH CONTAINERS

Order information:

MS-FTC40 Front Load (40L Single)
19"W * 17"D * 36"H (48*43*91cm)
MS-FTC40D Front Load (40L Double)
36"W * 17"D * 36"H (91*43*91cm)



[MS-FTC40]



Ashtray Option:
Stainless steel ashtrays:



S-ASH1
6-8/9"W x 6-2/5"D x 2-3/5"H
(17.5 x 16.2 x 6.6cm)



S-ASH2
5" Dia x 2"H
(12.5cmDia x 2.5cm)



TRASH BINS

- Constructed from maintenance free recycled plastic slats.
 - Open all sides allow them to be placed in any location.
 - Come with removable plastic inner bucket.
 - Hinged lids make removing inner bucket a breeze.
 - Capacity options: 40L(10Gal.) 60L (16Gal.) & 100L(26Gal.)
 - Available in three vivid colors (black, brown and green).
- Please specify color or color combination when ordering.

Order information:

96-STB40S	Trash Bin 40L-Single	20"W * 14"D*32.5"H (50* 36*83cm)
96-STB40D	Trash Bin 40L-Double	29"W * 17"D*32.5"H (74* 44*83cm)
96-STB40T	Trash Bin 40L-Triple	44"W * 17"D*32.5"H (112* 44*83cm)
96-STB60S	Trash Bin 60L-Single	20"W * 17"D*34"H (50* 44*86cm)
96-STB60D	Trash Bin 60L-Double	38"W * 17"D*34"H (96* 44*86cm)
96-STB60T	Trash Bin 60L-Triple	55"W * 17"D*34"H (140* 44*86cm)
96-STB100S	Trash Bin 100L-Single	22"W * 22"D*38"H (56* 66*97cm)
96-STB100D	Trash Bin 100L-Double	42"W * 20.5"D*38"H (107* 52*97cm)
96-STB100T	Trash Bin 100L-Triple	62"W * 20.5"D*38"H (158* 52*97cm)



[96-STB40S]



[96-STB60D]

TRASH BINS WITH ROOF

- Constructed from maintenance free recycled plastic slats.
- Open all sides allow them to be placed in any location.
- Attractive roof adds aesthetic value.
- Come with 40 liter inner plastic bucket.
- Available in three vivid colors (black, brown and green) . Please specify color or color combination when ordering.

Order information:

65P-STB40S	Trash Bin 40L-Single	22"W * 22"D*42"H (56* 56*107cm)
65H-STB40D	Trash Bin 40L-Double	34"W * 22"D*42"H (87* 56*107cm)
65H-STB40T	Trash Bin 40L-Triple	46"W * 20.5"D*42"H (118* 56*107cm)



[65P-STB40S]



[65H-STB40T]



[65H-STB40D]

ROUND AND SQUARE TRASH BINS

- Constructed from maintenance free recycled plastic slats.
- Come with a removable inner plastic bucket.
- Solid plastic lid.
- Available in three vivid colors (black, brown and green) .
Please specify color or color combination when ordering.



ROUND TRASH BINS

Order information:

65-RTB20	20L Round trash Bin	Φ 14"*18"H (Φ 35* 45cm)
65-RTB40	40L Round trash Bin	Φ 16"*25"H (Φ 40* 63cm)
65-RTB40L	40L Round trash Bin with Legs	Φ 16"*29"H (Φ 40* 74cm)
65-RTB70	70L Round trash Bin	Φ 21"*26"H (Φ 53* 66cm)
65-RTB90	90L Round trash Bin	Φ 23"*28"H (Φ 58* 71cm)

SQUARE TRASH BINS

Order information:

65-STB20	20L Square Trash Bin	13"W * 13"D*26"H (33* 33*45cm)
65-STB60	60L Square Trash Bin	19"W * 19"D*24"H (48* 48*60cm)
65-STB100	90L Square Trash Bin	21"W * 21"D*28"H (54* 54*70cm)

DIVOT MIX BOX ON WHEELS

- This durable and affordable small divot mix box is made of maintenance free recycled plastic
- Come with two wheels and a removable handle to make it more mobile.
- Simply place the handle in the coupling on the back to relocate the unit and the take the handle to the next box.
- Capacity: 40liter
- Available in three vivid colors (black, brown and green) and two-tone options. please specify color or color combination when ordering.

Order information:

HD-WDB Divot Mix Box with Wheels
18"W * 17"D*17.5"H
(45cm* 43cm*44cm)



[HD-WDB]

SMALL DIVOT MIX BOXES

- Constructed from maintenance free recycled plastic. Capacity: 25liter
- Top hinged lid keeps your divot mix dry and easily accessible.
- Two choices: short and tall configuration.
- Available in three vivid colors (black, brown and green) and two-tone options. please specify color or color combination when ordering.

Order information:

HN-DMB25S Small Divot Mix Box-Short
18"W * 13"D*12.5"H (45cm* 33cm*32cm)

HN-DMB25T Small Divot Mix Box-Tall
18"W * 13"D*27"H (45cm* 33cm*68cm)



[HN-DMB25S]



[HN-DMB25T]



Add your logo

HAND SCOOPS

Cast aluminium for light weight and prevention of rust.

Order information:

- 34451** 8 OZ hand scoop (236ml)
- 34452** 10 OZ hand scoop (296ml)
- 34453** 4 OZ hand scoop (120ml)
- 34454** 3 OZ hand scoop (88ml)
- 34455** 2 OZ hand scoop (60ml)

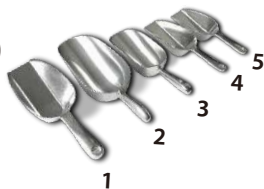

[3445]



[MS-DMB20]

SMALL DIVOT MIX BOXES

- This durable and affordable small divot mix box is made of maintenance free recycled plastic. Capacity: 20liter.
- Top hinged lid keeps your divot mix dry and easily accessible.
- Available in three vivid colors (black, brown and green), please specify color when ordering.

Order information:

MS-DMB20 Small Divot Mix Box
14"W * 14"D*12.5"H (36*36*32cm)

DIVOT MIX BOXES

- Constructed from maintenance free recycled plastic slats.
- Top hinged lid keeps your divot mix dry and easily accessible.
- Included removable plastic inner bucket in capacity 40, 60, or 100liter respectively.
- Available in three vivid colors (black, brown and green) . please specify color when ordering.



[96- DMB40]



[65- DMB60]

Order information:

- 96- DMB40** Divot Mix Box
19"W * 14"D*25"H (49* 36*64cm)
- 96- DMB60** Divot Mix Box
19"W * 19"D*28"H (49* 49*70cm)
- 96- DMB100** Divot Mix Box
22"W * 22"D*32"H (56* 56*81cm)
- 65- DMB60** Divot Mix Box
20"W * 20"D*24"H (51*51*61cm)
- 65- DMB100** Divot Mix Box
22"W * 22"D*29"H (56* 56*73cm)

DIVOT MIX CONTAINER

- Constructed from maintenance free recycled plastic.
- Top hinged lid keeps your divot mix dry and easily accessible.
- Available in three vivid colors (black, brown and green) . please specify color when ordering.



[96- DMC200]



[TD- DMC120]

Order information: (Without inner bucket)

- TD- DMC120** Divot Mix Container (Approx. 120 liter)
20"W * 20"D*30"H (51* 51*76cm)
- TD- DMC210** Divot Mix Container (Approx. 210 liter)
24"W * 24"D*35"H (60* 60*88cm)
- 96- DMC200** Divot Mix Container (Approx. 200 liter)
31"W * 20"D*29"H (79* 51*74cm)

DIVOT MIX CONTAINER

- Constructed from maintenance free recycled plastic.
- Available in three vivid colors (black, brown and green). please specify color or color combination when ordering.



[PS- DMCM]

Order information:

- PS- DMCM** Divot Mix Container
29.5"W * 29.5"D*25.5"H
(75* 75*65cm)

DIVOT MIX CONTAINERS

- Made mainly using 2.5cm thick heavy-duty recycled plastic, extremely strong and durable.
- Top fording hinged lid can be opened in half or full size for easy of use.
- Two size available for your choice.
- Available in three vivid colors (black, brown and green). Please specify color when ordering.

Order information:

- 25- DMCM** Divot Mix Container-Medium
37"W * 26"D*26"H (94* 66*66cm)
- 25- DMCL** Divot Mix Container-Large
54"W * 26"D*26"H (137* 66*66cm)



Fording hinged lid



[25- DMCM]

DIVOT BOTTLE RACKS

- These divot bottle racks are made from maintenance free recycled plastic.
- Can be folded up after use for easy storage .
- Available in three capacity: 16 bottles, 24 bottles and 32 bottles (bottle sold separately)
- Available in three vivid colors (black, brown and green) and two-tone options. please specify color or color combination when ordering.



[HN-DBR24]

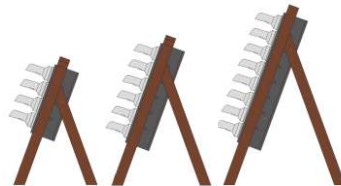

Order information:

- HN-DBR16** Divot Bottle Rack (16 bottles)
24"W * 26"D*37"H (61*66*94cm)
- HN-DBR24** Divot Bottle Rack (24 bottles)
24"W * 30"D*43"H (61*77*109cm)
- HN-DBR40** Divot Bottle Rack (40 bottles)
29"W * 37"D*52"H (73*94*132cm)



[3143]



[25-DBS2]

DIVOT BOTTLE

45oz bottom fill, curved neck, 14" Tall.

Order information:

3143 Divot Mix Bottle

DIVOT BOTTLE STAND

- Made of durable recycled plastic.
- Hold two divot bottles (bottle sold separately).
- Ideal for positioning this stand next to your busy par 3 tee boxes to encourage golfers to fill their divots after teeing off.
- Comes with two spikes.
- Color option: black, brown and green.

Order information:

25-DBS2 Divot Mix Bottle Stand

DIVOT BOTTLE CONTAINERS

- This divot bottle storage box is made of durable recycled plastic, can hold up to twenty-eight 45 oz. divot bottles (bottles sold separately)
- The open lid come with two Gas shocks to prevent any slamming when you shut it.
- Custom logo can be added upon request.
- Available in three vivid colors (black, brown and green) and two-tone options. please specify color or color combination when ordering.



[HD-DBC28]

Order information:

HD-DBC28 Divot Bottle Box
37"W * 20"D*35"H(94* 51*89cm)

DIVOT BOTTLE STAND

- This divot bottle stand is made of durable recycled plastic, can hold up to twenty-four 45 oz. sand divot bottles (bottles sold separately)
- Come with an empty bottle tray on the bottom
- Custom logo can be added upon request.
- Available in three vivid colors (black, brown and green) and two-tone options. please specify color or color combination when ordering.



[HS-DBS24]

Order information:

HS-DBS24 Divot Bottle Stand
45"W * 20"D*41"H (115* 51*105cm)

TRASH CONTAINER/DIVOT MIX BOX COMBINATIONS

These unique combinations promote convenience and create a great look to your golf course. Constructed with recycled plastic-wood which are rustproof, fade resistant and maintenance free.. Available in three vivid colors (black, brown and green) and two-tone options. please specify color or color combination when ordering.



T/DM CONTAINER COMBINATIONS

Order Information:

TD-T/DC60 Combination T1
60 liter trash bucket
38"W*20"D*30"H (97*51*76cm)

TD-T/DC100 Combination T2
100 liter trash bucket
44"W*23.5"D*34.5"H (112*60*88cm)



[TD-T/DC60]

T/DM CONTAINER COMBINATIONS

Order Information:

HN-T/DC60 Combination H1
60 liter trash bucket
37"W*19"D*35"H (93*48*89cm)

HN-T/DC100 Combination H2
100 liter trash bucket
43"W*22.5"D*40"H (109*57*101cm)



[HN-T/DC60]

T/DM CONTAINER COMBINATIONS

Order Information:

96-T/DC60 Combination S1
60 liter trash and 60 liter divot buckets inside.
43"W*18"D*28.5"H (109*46*73cm)

96-T/DC60 Combination S2
100 liter trash and 100 liter divot buckets inside.
46"W*22"D*33"H (118*56*84cm)



[96-T/DC60]

TRASH CONTAINER/DIVOT MIX BOX STATIONS

- You can choose our individual trash container and divot mix box to create your own trash and divot station.
- Here list some samples for your reference.
- Please specify color or color combination when ordering.

Order Information:

Station S11

- 65P-TB40S** Trash Bin (40 liter)
22"W * 22"D*42"H (56* 56*107cm)
- 65- DMB60** Divot Mix Box (60 liter)
20"W * 20"D*24"H (51* 51*61cm)

Station S21

- 96-TB40S** Trash Bin (40 liter)
20"W * 14"D*32.5"H (50* 36*83cm)
- 96- DMB40** Divot Mix Box (40 liter)
20"W * 14"D*25"H (50* 36*64cm)

Station HD11

- HD-STB60S** Front Load (60 liter)
19"W * 19"D*35"H (49* 49*89cm)
- TD- DMC120** Divot Mix Container
19"W * 19"D*30"H (49* 49*76cm)

Station TD11

- TD-STC60S** Front Load (60 liter)
19"W * 19"D*34"H (49* 49*87cm)
- TD- DMC120** Divot Mix Container
19"W * 19"D*30"H (49* 49*76cm)



[Station S11]



[Station S21]



[Station HD11]



[Station TD11]



CLUB RACK

Constructed with recycled plastic.
Rustproof, fade resistant and
maintenance free
Tiered rack holds 66 clubs.
Assembly required
Please specify color when ordering.

Order information:
34111 Club Rack



[34111]

DEMO CLUB RACK

- The same construction as 66-club Rack.
- Added surfaces can be customized with your brand name, logo or other message.
- A great rack for any club vender or pro shop to display clubs during Demo event.

Order information:
34121 Demo Club Rack



[34121]

UMBRELLA RACK

Constructed with recycled plastic.
Rustproof, fade resistant and
maintenance free
Tiered rack holds 40 umbrellas.
Assembly required
Please specify color when ordering.

Order information:
34131 Umbrella Rack



[34131]

CLUB HOLDER

This Club Holder can display 18 clubs.
Please specify color when ordering.

Order information:
3415 Club Holder



[3415]

LOTUS BALL WASHERS

- Cast from durable, rust free aluminium.
- Internal parts are stainless steel and high strength plastic.
- Simple design, only on moving part.
- Mount to standard 2-3/8" (6cm) O.D. pipe.
- All replacement parts are available.
- Stock colors: Red, Green and Black.

Order information:

- 301R** Lotus Ball Washer-Red
301G Lotus Ball Washer-Green
301B Lotus Ball Washer-Black



[301G]

STOCK COLORS:



[301G]



[301R]



[301B]

BALL WASHER CONSOLE UNITS

For your convenience, here are some ball washer console units. Pick one of our popular package, or create your own packages by yourself with different combinations.



UNIT 1

BALL WASHER CONSOLE UNIT 1

- Order information:
3101R Unit 1-Red
3101G Unit 1-Green
3101B Unit 1-Black



UNIT 2

BALL WASHER CONSOLE UNIT 2

- Order information:
3102R Unit 2-Red
3102G Unit 2-Green
3102B Unit 2-Black



UNIT 3

BALL WASHER CONSOLE UNIT 3

- Order information:
3103R Unit 3-Red
3103G Unit 3-Green
3103B Unit 3-Black



WASTE MATE TRASH RECEPTACLES

- Durable polyethylene, no rust, no dent.
- The bottom container is available in (3) colors: Red, Green & Black. And the lid color is black only.
- Capacity: 9 gal. (34 liter)
- Designed to stack for shipping.
- Please specify lid style when ordering.

Order information

- 3050R** Waste mate-Red
- 3050G** Waste mate-Green
- 3050B** Waste mate-Black
- 30501** Trash Lid
- 30502** Solid Lid



[3050]



[30501]



[30502]

WASTE MATE STANDS

Steel bracket with two stands makes the trash mate freestanding on the ground. Steel bracket with double spikes keeps the trash mate in place

Order information

- 3070** Low Stand
- 3071** Spiked Stand

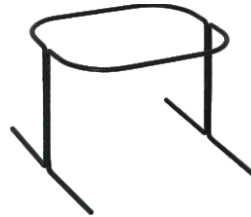

[3070]



[3071]

WASTE MATE TRASH BINS

The combination of Waste Mate Trash receptacle and Waste mate Stands make the Waste Mate freestanding anywhere they are needed.

Order information

- 3081** Low Stand Trash Bin
 - 3082** Spiked Stand Trash Bin
- (Please specify colors when ordering.)



[3081]



[3082]

WASTE MATE POLE MOUNTING KIT

Made of aluminium alloy, surface anodized black.

Order information:

- 3061** Single Unit Pole Mount Kit (All three pieces including hardware)
- 30611** Hoop Frame
- 30612** Mounting Bracket
- 30613** Back Clamp
- 3062** Single Unit Pole Mount Kit (All four pieces including hardware)

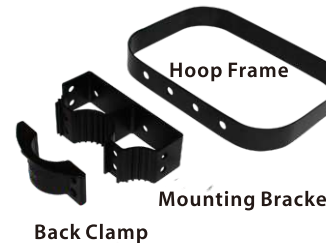

[3061]



[3062]

TEETOWELS

100% cotton tee towels. Green color.
18"x18" (46cmx46cm) size with brass grommet.
Two style for your choice: Trifold with central grommet .

Order information:
31631 Trifold Tee Towel with central grommet
31632 Trifold Tee Towel with corner grommet



[31631G]



[31632G]

BALL WASHER REPAIR KIT

Order information:
3000 Ball Washer Repair Kit (Complete Kit)



[3000]

MOUNTING PIPE

2-3/8" (6cm)O.D aluminium pipe.
Powder-coated black finish.

Order Information
30021 34 inch (87cm) long
30022 48 inch (122cm) long



[30021]

[30022]

BALL WASHER BRACKET

Mount ball washer to any flat surface.
Powder coated black aluminium.

Order Information
3010 Ball Washer Bracket



[3010]

ALUMINIUM BASE

Cast aluminium, 18" (46cm) dia.
spikes included for stability.

Order Information
3001R Red
3001G Green
3001B Black



[3001G]

BALL WASHER COMPOSITE

Trash bin come with 40 liter inner plastic bucket. Ball washer round post can be firmly connected to trash bin side wall. Please specify color when ordering .

Order information:
301-BWC Ball Washer Composite



[301-BWC]

BALL WASHER TEE CONSOLE

This Tee console includes 40 liter waster enclosure, a ball washer and custom tee signage. We can help design custom tee station with tee signs and logo application. Contact us for details.

Order information:
301-BWT Ball Washer Tee Console



[301-BWT]

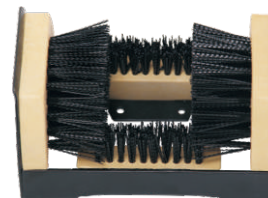

[3173]

SHOE CLEANER

Cleaning is both quick and effortless with 4 separate brushes.

Order information:
3173 Shoe cleaner

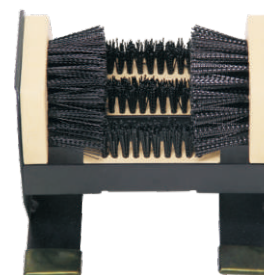

[3174]

DELUXE SHOE CLEANER

Our new model shoe cleaner come from 31731 with two standing legs added, it can be free-standing or ground-mounted.

Order information:
3174 Deluxe Shoe Cleaner

STAND SHOE BRUSH

This unit comes with twin shoe cleaners for easy shoe cleaning. 32-1/4" (82cm) Tall. The stand and base are constructed with powder coated steel, and easily mounts to the ground with four mounting holes.

Order information:
3170 Stand shoe brush



[3170]



BROKEN TEE CADDY

Recycled plastic lumber caddy. 4"(10cm) high with steel mesh base.

Order information:
3150 Broken tee caddy



[3150]



SCORECARD CADDY

- Made from recycled plastic, rust proof, fade resistant and maintenance free.
- Three compartments for scorecards, pencils and tees.
- 9cm*9cm*150cm recycled plastic post included.
- Color: green and brown.
- 42cmW*37cmD*12.5cmH (not include post)

Order information:
3155 Scorecard Caddy
 Please specify color when ordering.



[3155]



[3152]

DRAW STRAWS

- This useful tool help you to decide the honor who is to play first form teeing ground or in schedule order.
- Made of entirely aluminium alloy and anodized surface.
- Plastic stake included.

Order information:
3152R Draw Straws-red
3152B Draw Straws-Blue



TEE HOLDER

- 30cm Dia. plastic board holds a hundred tees.
- 100cm aluminium post plus stainless steel stake.
- Come with cigar rest mounted on the post.
- A great addition to any tee area.
- Your course's name, logo can be added on the center of board.

Order information:
3154 Tee Holder



[3154]

PLASTIC TEE MARKER

- These plastic Tee Markers are made of solid recycled plastic.
- Come standard with one stainless steel spike base, available with two-spike base upon request for more stable mounting.
- Tee Marker float.
- Stock color: Red, White, Blue, Yellow, Black.
- Please specify color when ordering.



2-COLOR CAPITAL TEE MARKER

Black Tee Marker with Tee position color strips.
4"W x 4"D x 6"H (10 x 10 x 15cm)

Order information:

100-CTM2 2-Color Capital Tee Marker

100-CTM2L 2-Color Capital Tee Marker with LOGO



[100-CTM2]



[100-CTM2L]



[100-TTM2]

TRIANGLE TEE MARKER

4"W x 5.6"D x 2.8"H (10 x 14 x 7cm)

Order information:

100-TTM Triangle Tee Marker

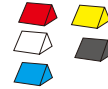

[100-CBTM]

CAPITAL TEE MARKER

4"W x 4"D x 6"H (10 x 10 x 15cm)

Order information:

100-CTM Capital Tee Marker



[100-WTMH]

HORIZONTAL WEDGE TEE MARKER

4"W x 5"D x 4"H (10 x 13 x 10cm)

Order information:

100-WTMH Horizontal Wedge Tee Marker

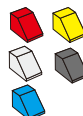

[100-TTM2]

CUBE TEE MARKER

4"W x 4"D x 4"H (10 x 10 x 10cm)

Order information:

100-CBTM Cube Tee Marker



[100-PTM]

PRISM TEE MARKER

4"W x 4"D x 6"H (10 x 10 x 15cm)

Order information:

100-PTM Prism Tee Marker

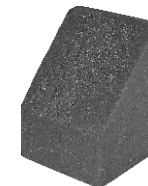

[100-WTMV]

VERTICAL WEDGE TEE MARKER

4"W x 4"D x 5"H (10 x 10 x 13cm)

Order information:

100-WTMV Vertical Wedge Tee Marker

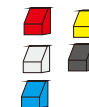

PLASTIC TEE MARKER

- These plastic Tee Markers are made of solid recycled plastic;
- Come with stainless steel spike for easy in-ground mount;
- Tee Marker float;
- Stock colors: Red, White, Blue, Yellow, Black.
- Please specify color when ordering.
- Thickness: 2.5cm



[25-LDTM]



[25-DTM]

LOW PROFILE DISC TEE MARKER

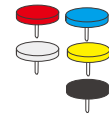

Φ4" x 1"H (Φ 10 x 2.5cm)

Order information:

25-LDTM Low Profile Disc Tee

DISC TEE MARKER WITH NECK



5"W x 1"D x 5.7"H (10 x 2.5 x 14cm)

Order information:

25-DTM Disc Tee Marker with Neck

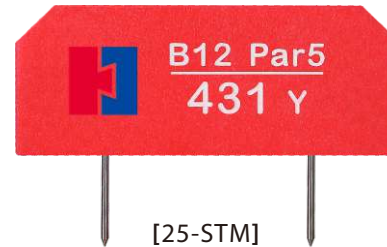

[25-STM]

SIGNAGE TEE MARKER

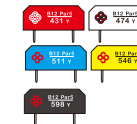

12"W x 1"D x 5"H (30 x 2.5 x 13cm)

Order information:

25-STM Signage Tee Marker

CUSTOM TEE MARKERS

We can help you design custom Tee Markers in any shape and size.

Order information:

25-CTMK Custom Tee Marker



DIMPLE TEE MARKERS

The Dimple tee markers are made of solid ABS plastic with a stainless steel spike. It won't split or crack, there's no paint to chip and UV protection makes it fade resistant. A full 5 in. (13cm) diameter.

PLAIN DIMPLE TEE MARKERS

Plain Dimple Tee Marker is 5 inches ball (1.3cm) in diameter

Order information:

- 3121A** Plain Dimple T- marker-Red
- 3121B** Plain Dimple T- marker-White
- 3121C** Plain Dimple T- marker-Blue
- 3121D** Plain Dimple T- marker-Yellow
- 3121E** Plain Dimple T- marker-Black



[3121C]

PERSONALIZED DIMPLE TEE MARKERS

Personalized Dimple Tee Marker with additional beveled face to stick custom logo. Decal priced separately.

Order information:

- 3122A** Personalized Dimple T- marker-Red
- 3122B** Personalized Dimple T- marker-White
- 3122C** Personalized Dimple T- marker-Blue
- 3122D** Personalized Dimple T- marker-Yellow
- 3122E** Personalized Dimple T- marker-Black

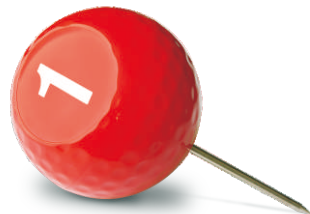

[3122A]



Decals

BALL TEE MARKERS

Solid ball tee markers are made of durable resin. Color pigments are added directly into the resin. Metal nuts are molded-in and Stainless steel spike can be easy screwed in and out for convenient transportation.



BALL TEE MARKERS

4.5 inches(11 cm) in diameter.

Order information:

- 3123A** Ball T- marker-Red
- 3123B** Ball T- marker-White
- 3123C** Ball T- marker-Blue
- 3123D** Ball T- marker-Yellow
- 3123E** Ball T- marker-Black



[3123C]

BALL TEE MARKER WITH NECK

Solid 5" (13cm) ball plus a unique neck keeps the marker at same height while minimize grass burnout spots.

Order information:

- 3120A** Ball T- marker with neck-Red
- 3120B** Ball T- marker with neck-White
- 3120C** Ball T- marker with neck-Blue
- 3120D** Ball T- marker with neck-Yellow
- 3120E** Ball T- marker with neck-Black



[3120A]

PERSONALIZED TEE MARKERS

Solid ball tee markers with neck can be customized with a addition beveled face for sticking custom logo, or molded with custom logo. Contact us for details.

Order information:

- 3120P1** Personalized Tee Markers with decal
- 3120P2** Molded Custom Tee Markers



[3120P1]



[3120P2]

BRANCH AND LOG TEE MARKER

Molded from strong and durable resin and the slanted ends are hand painted to any colours.
Metal nuts are molded-in and stainless steel spikes can be easy screwed in and out to convenient transportation.



BRANCH TEE MARKER

3-1/3" Dia x 10-3/5" W (8cm Dia. x 27cm W)

Order information:

- 3124A** Branch tee marker -Red
- 3124B** Branch tee marker -White
- 3124C** Branch tee marker -Blue
- 3124D** Branch tee marker -Yellow
- 3124E** Branch tee marker -Black
- 3214-ED** Custom Branch Tee Marker with End-Decals
- 3214-ML** Custom Molded Branch Tee Marker with LOGO

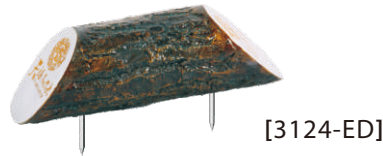

LOG TEE MARKER

4" Dia. x 4-1/4" H (10cm Dia. x 11cm H)

Order information:

- 3125A** Log tee marker -Red
- 3125B** Log tee marker -White
- 3125C** Log tee marker -Blue
- 3125D** Log tee marker -Yellow
- 3125E** Log tee marker -Black
- 3214-TD** Custom Branch Tee Marker with Top-Decals
- 3214-ML** Custom Molded Branch Tee Marker with LOGO



[3124C]



[3125-TD]



[3125-ML]



CUSTOMIZED TEE MARKERS

To make your Tee Marker more attractive and personalized, you can design your own tee marker and let us make your design come true. For just a little more money, your golfer will love it.

Please see some samples of custom tee marker listed here. These attractive tee maker are molded from extremely strong and durable resin. Any custom shape can be produced from your supplied designs.

If you have a special design or tee marker concept in mind, we make it happen.

Order information:

- 312C** Custom Tee Marker





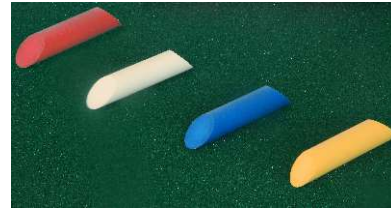

RECYCLED LOG TEE MARKER

- Made from round 2inch(5cm) diameter recycled plastic post.
- Two stainless steel spikes.
- Available colors: Red, White, Blue and Yellow.
- Φ2" x 10. 6" (Φ5 x 27cm)



[50-LTM]

- Order information:
-  **50-LTMR** Recycled Log Tee Marker-Red
 -  **50-LTMW** Recycled Log Tee Marker-White
 -  **50-LTMB** Recycled Log Tee Marker - Blue
 -  **50-LTMY** Recycled Log Tee Marker - Yellow

FLAG TEE MARKERS

Come with 2"(5cm) white base plus stainless steel spike.

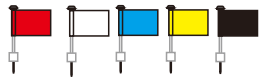

- Order information:
- 50-FTMR** Flag Tee Marker-Red
 - 50-FTMW** Flag Tee Marker-White
 - 50-FTMB** Flag Tee Marker - Blue
 - 50-FTMY** Flag Tee Marker - Yellow
 - 50-FTMBL** Flag Tee Marker - Black



[50-FTM]

ZINC ALLOY TEE MARKERS

Custom zinc alloy Tee Marker with stainless steel spike. Available single or double sided.

- Order information:
- ZA-CTM** Zinc Alloy Custom Tee Marker



[ZA-CTM]

COLORFUL PLASTIC TEE DECK MARKERS

- Made of heavy-duty 2.5cm thick solid recycled plastic;
- Super durable and fade resistance.
- Engraved message and poured.
- Available in Red, White, Blue, yellow, Black, Dark green and Brown.
- Dimension: 12" square(30x30cm);
12" round (Dia30cm);
12" x 8"rectangular (30 x 20cm)
Custom size are available upon request.
- Please specify color when ordering .
- Come with stainless steel spike to secure marker.

Order information:

- Colorful Tee Deck Yardage Markers
- 25-STD30** 12" square(30x30cm);
 - 25-RTDM30** 12" round (Dia30cm);
 - 25-TDM3020** 12" x 8" rectangular (30 x 20cm)
 - 25-TDMKC** Custom Size



[25-STD30]



[25-RTDM30]



[25-TDM3020]

PAR3 DISTANCE SIGN

- Give your golfers exact distance to the hole with this durable sign.
- To reduce pace of play by assisting golfers to select their club in advance.
- Constructed of recycled plastic, available in Dark Green, Brown and Black;
- Yardage number available in white and black laminate plastic.
- Aluminium track and yardage numbers are in 3.5"(9cm) size and are fully interchangeable.
- A small slot on the back for storage of yardage number
- Come with stainless steel spike to secure the sign.
- Please specify color when ordering.



[MS -P3DS]



[Back View]

Order information:

- MS -P3DS** Par 3 Distance Sign
(Sign only, numbers sold separately)
- LN-3T** Interchangeable Numbers , 3" Set of 10 (0-9)



[LN-3T]

RECYCLED PLASTIC SIGNS WITH SPIKES

- Made using 1" (2.5cm) thick recycled plastic with two stainless steel spikes. Weather resistant, extremely durable and affordable.
- Message can be engraved either single side or double sides. Resin-poured texts.
- Please specify color and select sign size when ordering (standard size see below), custom size also available.



Order information

Please specify texts, see below:

25-S6030S- ___ 60*30*2.5 cm Sign, Single Sided

25-S6030D- ___ 60*30 *2.5cm Sign, Double Sided

25-S5030S- ___ 50*30*2.5 cm Sign, Single Sided

25-S5030D- ___ 50*30*2.5 cm Sign, Double Sided

25-S3030S- ___ 30*30 *2.5cm Sign, Single Sided

25-S3030D- ___ 30*30 *2.5cm Sign, Double Sided

25-S3823S- ___ 38*23 *2.5cm Sign, Single Sided

25-S3823D- ___ 38*23 *2.5cm Sign, Double Sided

25-S4020S- ___ 40*20 *2.5cm Sign, Single Sided

25-S4020D- ___ 40*20 *2.5cm Sign, Double Sided

25-S3015S- ___ 30*15 *2.5cm Sign, Single Sided

25-S3015D- ___ 30*15 *2.5cm Sign, Double Sided

25-S2714S- ___ 27*14 *2.5cm Sign, Single Sided

25-S2714D- ___ 27*14 *2.5cm Sign, Double Sided

25-AS3013S- ___ 30*13 *2.5cm Arrow Sign, Single Sided

25-AS3013D- ___ 30*13 *2.5cm Arrow Sign, Double Sided

25-CSS Custom Sign, Single Sided



[25-S2714-02]



[25-S2714-08]



[25-S2714-03]



[25-S6030C]



[25-CSS]



[25-CSS]

- | | |
|-----------------------------------|-------------------------------|
| -01 Ground Under Repair | -10 Wet Area Carts Keep Off |
| -02 Drop Area | -11 No Carts |
| -03 Next Tee (with one way arrow) | -12 Keep Carts 30' From Green |
| -04 Please Repair Ball Marks | -13 No Chipping |
| -05 Please Replace Divots | -14 Please Observe 90° Rule |
| -06 Please Rake Bunkers | -15 Putting Green Closed |
| -07 Please Keep Off | -16 Driving Range Closed |
| -08 Carts (with one way arrow) | -17 Chemicals Applied Today |
| -09 Keep Carts On Path | -18 Customized Signs |

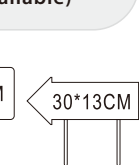
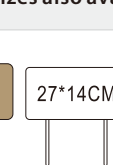
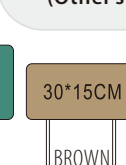
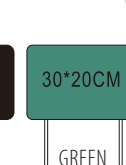
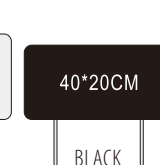
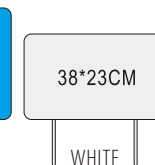
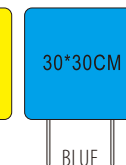
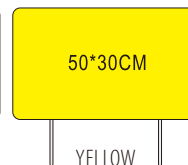

SIGN SIZE & COLOR OPTIONS
(Other sizes also available)

LAMINATED PLASTIC SIGNS WITH SPIKES

Made of two-tone laminated plastic, the message or logo is engraved through the upper surface to expose the next color. These signs can be made in any sizes and will withstand beatings by golf clubs, balls and many of the typical vandal problems regularly encountered. Tough, long-lasting and outstanding fade-resistance.

- 2.0 cm thick.
- Only green/white letters available at present.
- Please select sign size when ordering (see below), custom size also available.

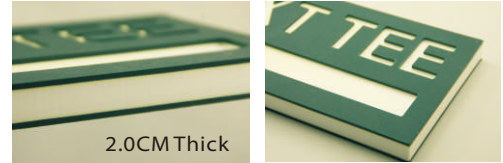

[20L-S3015S-03]



[20L-S3015S-04]



[20L-S3823S]



[20L-3040C]

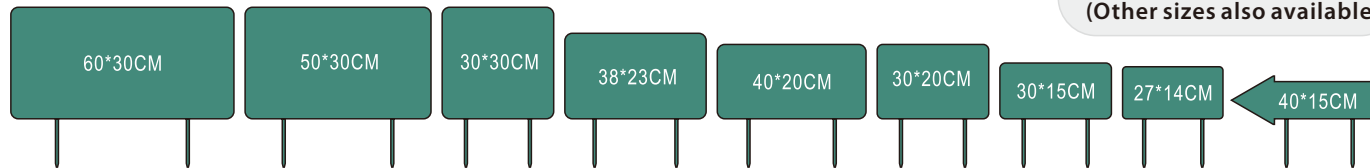

SIGN SIZE OPTIONS
(Other sizes also available)

LAMINATED PLASTIC SIGNS WITH SPIKES

Order information

Please specify message, see below:

- 20L-S6030S-** ___ 60*30 *2cm Sign, Single Sided
- 20L-S6030D-** ___ 60*30 *2cm Sign, Double Sided
- 20L-S5030S-** ___ 50*30 *2cm Sign, Single Sided
- 20L-S5030D-** ___ 50*30 *2cm Sign, Double Sided
- 20L-S3030S-** ___ 30*30 *2cm Sign, Single Sided
- 20L-S3030D-** ___ 30*30 *2cm Sign, Double Sided
- 20L-S3823S-** ___ 38*23 *2cm Sign, Single Sided
- 20L-S3823D-** ___ 38*23 *2cm Sign, Double Sided
- 20L-S4020S-** ___ 40*20 *2cm Sign, Single Sided
- 20L-S4020D-** ___ 40*20 *2cm Sign, Double Sided
- 20L-S3020S-** ___ 30*20 *2cm Sign, Single Sided
- 20L-S3020D-** ___ 30*20 *2cm Sign, Double Sided
- 20L-S3015S-** ___ 30*15 *2cm Sign, Single Sided
- 20L-S3015D-** ___ 30*15 *2cm Sign, Double Sided
- 20L-S2714S-** ___ 27*14 *2cm Sign, Single Sided
- 20L-S2714D-** ___ 27*14 *2cm Sign, Double Sided
- 20L-AS4015S-** ___ 40*15 *2cm Arrow Sign, Single Sided
- 20L-AS4015D-** ___ 40*15 *2cm Arrow Sign, Double Sided

- 01 Ground Under Repair
- 02 Drop Area
- 03 Next Tee (with one way arrow)
- 04 Please Repair Ball Marks
- 05 Please Replace Divots
- 06 Please Rake Bunkers
- 07 Please Keep Off
- 08 Carts (with one way arrow)
- 09 Keep Carts On Path
- 10 Wet Area Carts Keep Off
- 11 No Carts
- 12 Keep Carts 30' From Green
- 13 No Chipping
- 14 Please Observe 90° Rule
- 15 Putting Green Closed
- 16 Driving Range Closed
- 17 Chemicals Applied Today
- 18 Customized Signs

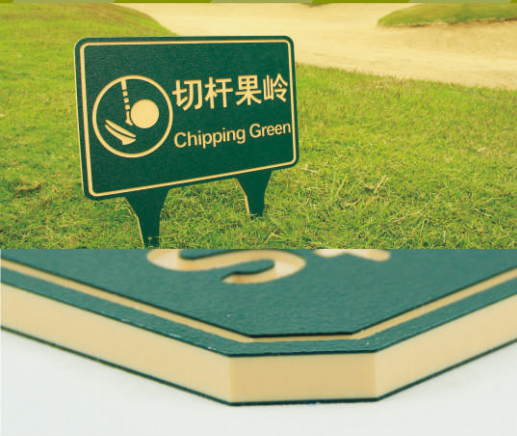

ONE-PIECE LAMINATED SIGNS

Order information

Please specify texts, see below:

10L-S3220S- ___ 32*20*1 cm Sign, Single Sided

10L-S3220D- ___ 32*20*1cm Sign, Double Sided

10L-S2317S- ___ 23*17*1 cm Sign, Single Sided

10L-S2317D- ___ 23*17*1 cm Sign, Double Sided

10L-AS3512S- ___ 35*12*1cm Arrow Sign, Single Sided

10L-AS3512D- ___ 35*12*1cm Arrow Sign, Double Sided

10L-CSS Custom Sign, Single Sided

10L-CSD Custom Sign, Double Sided

ONE-PIECE LAMINATED SIGNS

- Made from tough, long-lasting, solid two-tone laminated plastic, one-piece construction. 1.0cm thick.
- Hard enough to make sign and spikes in one piece.
- Engraved message on single side or both sides.
- only green/beige color available at present.
- Custom sizes are available upon request.



[10L-S3512D-03]



[10L-S2815S-09]



[10L-S2317S-02]



[10L-S3220S-07]



[10L-S3220S-01]



[10L-CSS]

- 01 Ground Under Repair
- 02 Drop Area
- 03 Next Tee (with one way arrow)
- 04 Please Repair Ball Marks
- 05 Please Replace Divots
- 06 Please Rake Bunkers
- 07 Please Keep Off
- 08 Carts (with one way arrow)
- 09 Keep Carts On Path
- 10 Wet Area Carts Keep Off
- 11 No Carts
- 12 Keep Carts 30' From Green
- 13 No Chipping
- 14 Please Observe 90° Rule
- 15 Putting Green Closed
- 16 Driving Range Closed
- 17 Chemicals Applied Today
- 18 Customized Signs

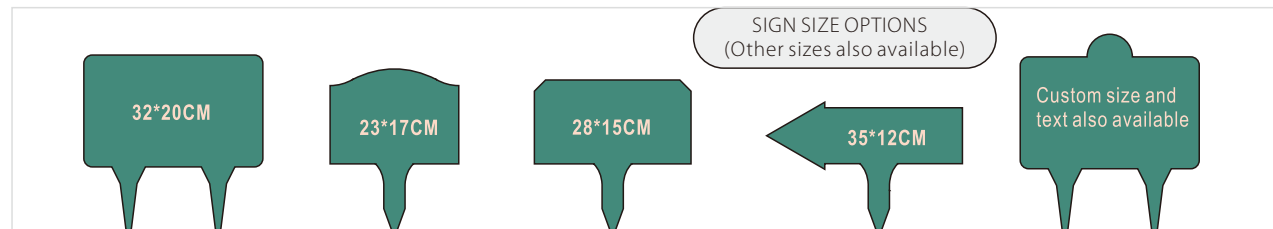

TWO-TONE REAME SIGNS

- Two-tone combinations in frame and panel.
- Made from tough, long-lasting, recycled plastic.
- Complete with two stainless steel spikes.
- Custom Logo and message can be added on single side or both sides.
- Please specify color combinations when ordering.

Order information:

- FP-S6045** Frame Sign 24"W*18"H (60*45cm)
- FP-S4530** Frame Sign 18"W*12"H (45*30cm)
- FP-S3525** Frame Sign 14"W*10"H (35*25cm)
- FP-Custom** Frame Sign Custom Size



[FP-S3525]



[FP-S4530]



[FP-S6045]

PAPER-INSERT WINDOW SIGNS

- Made from tough, long-lasting, HDPE plastic. 2.0cm thick.
- Recessed backing board and transparency acrylic plate forms a gap to fit for paper insert.
- Complete with two stainless steel spikes.
- Custom logo can be added upon request.

Order information:

- WS-A5H** Fit for A5 paper (Horizontal type)
- WS-A4V** Fit for A4paper (Vertical type)
- WS-A4H** Fit for A4 paper (Horizontal type)
- WS-A3V** Fit for A4 paper (Horizontal type)

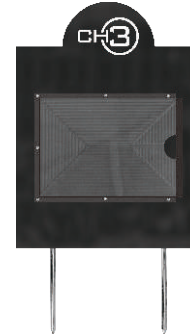

[WS-A5H]

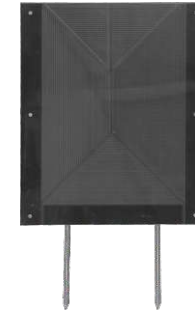

[WS-A4V]

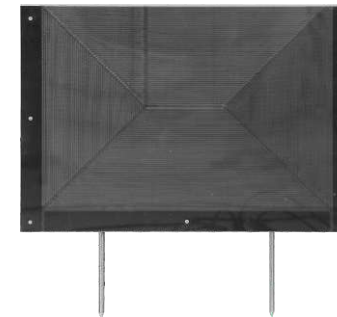

[WS-A3H]

POST-MOUNT SIGNS (SHORT CONFIG)

- These signs and posts are made of durable recycled plastic.
- A wide range of sign colors and sizes/shapes available to suit custom any needs (shown on below).
- Engraved and Resin-poured texts.
- You can design your own sign with your desired configuration.



POST-MOUNT SIGNS

Made using 2.5cm thick recycled plastic.
Ready to mount on post.
Color options: Red, white, blue, yellow, black, green, brown.

Order information:

Please specify texts and color:

- 25-53011 30*11*2.5 cm
- 25-53820 38*20*2.5 cm
- 25-54025 40*25*2.5 cm
- 25-55428 54*28*2.5 cm arrow
- 25-55015 50*15*2.5 cm arrow
- 25-53030 30*30*2.5 cm
- 25-53530 35*30*2.5 cm
- 25-54030 40*30*2.5 cm
- 25-54630 46*30*2.5 cm
- 25-54630 60*30*2.5 cm



POSTS (SHORT CONFIG)

Double-post Config

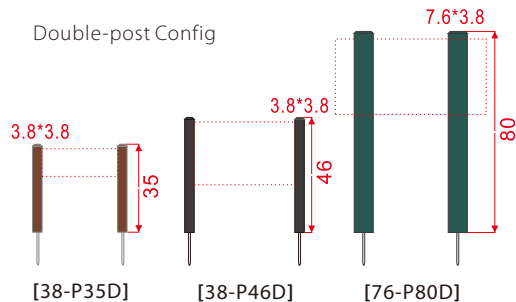

DOUBLE POSTS

Available color: Green, brown and black.

Order information (Please specify color):

- 38-P35D Double Post (3.8*3.8*35 cmH + Spike)
- 38-P46D Double Post (3.8*3.8*46 cmH + Spike)
- 76-P80D Double Post (7.6*3.8*80 cmH + Spike)

Single-post Config

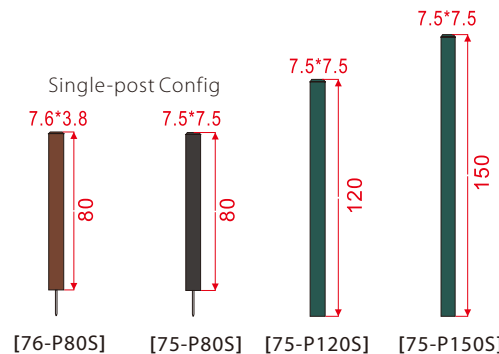

SINGLE POSTS

Available color: Green, brown and black.

Order information (Please specify color):

- 76-P80S Single Post (7.6*3.8*80 cmH + Spike)
- 75-P80S Single Post (7.5*7.5*80 cmH + Spike)
- 75-P120S Single Post (7.5*7.5*120 cmH)
- 75-P150S Single Post (7.5*7.5*150 cmH)

POST-MOUNT SIGNS (TALL CONFIG)

- These signs and posts are Made of durable recycled plastic.
- A wide range of popular shape/sizes ready for your choice (shown on left).
- Engraved and Resin-poured texts.
- You can design your own sign with your desired configuration.



POST-MOUNT SIGNS

Made of durable recycled plastic. Ready to mount on post. Color options: Black, green, brown.

Order information:

Please specify texts and color:

- PS-3851** Post-mount Sign (38*51cm)
- PS-4651** Post-mount Sign (46*51cm)
- PS-4661** Post-mount Sign (41*61cm)
- PS-5428** Post-mount Sign (56*61cm)
- PS-Custom** Post-mount Sign

SIGN POSTS

Available color: Green, brown and black .

Order information (Please specify color):

- 75-P160** 7.5*7.5*160cm
- 75-P240** 7.5*7.5*240cm
- 90-P240** 9*9*240cm

SHAPE and SIZE

		SIZE: 38*51cm
		SIZE: 46*51cm
		SIZE: 46*61cm
		SIZE: 56*61cm

Chose from one of our more popular shapes, or design your own.



SIGN POSTS

9*9*160

9*9*240

INFORMATION AND NOTICE SIGNS

- These information or Notice sign can be made in big size up to 122*244cm.
- Signs can be either engraved or UV digital printed.
- UV digital printed signs are suitable for indoor or outdoor use, any information can be printed on the sign face, especially good for picture printing.
- Interchangeable plaques slide into aluminium channels to create everyday information.
- Can be mounted either on the wall or on the post.
- Long lasting and maintenance free.
- Customized signs: You design your own signs and let us do all for you.



[SE-4668]
Engraved Sign 46*68cm



[SE-14090]
Engraved Sign 140*90cm



[SE-120160]
Engraved Sign 120*160cm



[SE-80120]
Engraved Sign 80*120cm



[SE-200100]
Engraved Sign 200*100cm



[SY-100180]
Digitally printed Sign 100*180cm



WALL-MOUNT SIGNS



[SE-5080]
Engraved Sign 50*80cm



[SE-6080]
Engraved Sign 60*80cm



[SY-120240]
Digitally printed Sign 120*240cm

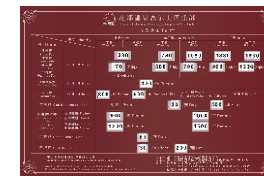

[SY-240120]
Digitally printed Sign 240*120cm

ALUMINIUM DECORATIVE POST SIGNS

- 3" (7.6cm) round decorative post with fluted base. The sign post, fluted base and mounting brackets are all cast aluminium and powder coated finish.
- Mounting bracket options: single side mounting, double side mounting, hanging mounting, face mounting and fingerpost mounting.
- Sign options: Tee signs, direction signs, information signs, fingerpost arms;
- Come with one 28" underground mounting anchor for easy installation.

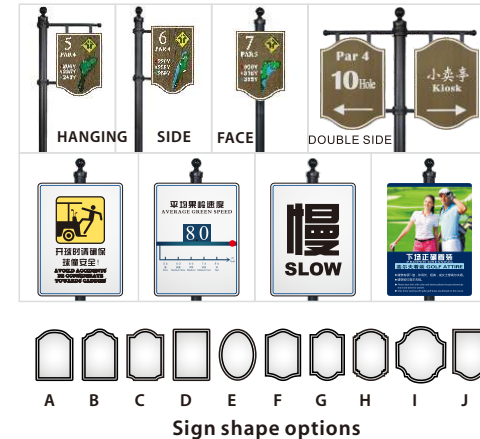
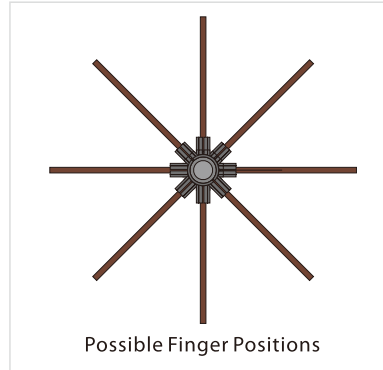

[3621H]



[3621D]



[3621F]

ALUMINIUM DECORATIVE POST SIGNS

- Signs can be made of recycled plastic with engraved message or aluminium sign with digital printed message.
- Color options for recycle plastic signs: Brown, black and green.
- Tee signs can come with logo, hole number, par, up to (5) yardages & hole layout map.
- Signs are available in different sizes and shapes, you can design your own sign, and let us do the rest.

Order information:

- 3621H** Decorative Post Sign-hanging
- 3621S** Decorative Post Sign-Side
- 3621F** Decorative Post Sign-Face
- 3621D** Decorative Post Sign-Double Side

ALUMINIUM FINGER POST SIGNS

- Signs are made of recycled plastic, engraved message and poured.
- Signs color options: Brown, black and green.
- Arms can be positioned in any direction.
- Arm style can be flat head or arrow head.
- Please specify signs color, arm style and numbers of arm.

Order information:

- 3621F** Aluminium Decorative Post only
- 3621FR** Single Arm (Sign and mounting bracket)

GRANITE TEE SIGNS

Grey granite base with polished black granite sign face.

Order information:

3631 Granite Tee Signs

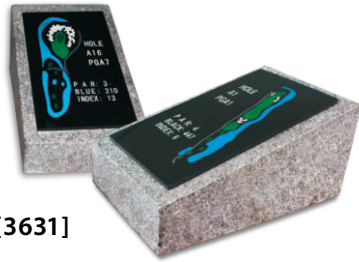

[3631]



[25-TS90]

ONE-PIECE TEE SIGNS

- Made using 2.5cm thick recycled plastic slat, one-piece construction.
- Can be customize with logo, hole number, par , up to (5) yardages & hole layout map.
- Available Colors:brown, black and green.

Order information:

25-TS90 One-piece Tee Sign



[3632]

UPRIGHT GRANITE TEE SIGNS

- Granite base with logo, recycled plastic sign
- 100cm height.

Order information:

3632 Upright Granite Tee Signs



[MS-ST564]

SLANTED HEAD TEE CONSOLE

- Slanted tee sign provides a comfortable angle of view.
- Tee Sign can be changed effortlessly and updated at any time to suit your needs.
- Engraved Tee sign can be customized with logo, hole number, par , up to (5) yardages & hole layout map.
- Sponsor sign can be added at front panel.
- Dimension: 25"W*12"D*48"H (64*31*122cm)
- Console color options: Brown, black and green.
- Sign color options: green, brown and black.
- Come with ground locking sleeves.

Order Information:

MS-ST564 Slanted Head Tee Console



[150-TP130]

TEE POSTS

- 6"(15*15cm) square semi-hollow post.
- Acrylic plates : printed on the reverse side with Tee information.
- Tee information plate recessed into the post.
- Post color options: Brown or black .
- Post heights: 35"(90cm) or 52" (130cm).
- Please specify signs color when ordering.

Order information:

150-TP90B Tee Post (90cm H , Beveled Top)

150-TP90C Tee Post (90cm H , Cap Top)

150-TP130B Tee Post (130cm H , Beveled Top)

150-TP130C Tee Post (130cm H , Cap Top)



TEE SIGNS

- Constructed fully from recycled plastic.
- Engraved Tee signs with logo, hole number, par , up to (5) yardages & hole layout map.
- Tall profile dimension: 39"W*96"H (99*244cm).
- Low profile dimension: 48"W*48"H (122*122cm).
- You can design your own sign, or provided the requisite information and logo file, we'll provide you with a visual proof to approve or request changes.
- Color options: Brown, green and black.

SINGLE-POST TEE SIGNS

Ordering information:

- PS-1PTS** Single-post Tee Sign
- PS-1PTSD** Single-post Tee Sign (Double sided)

TWO-POST TEE SIGNS

Ordering information:

- PP-2PTS** Two-post Tee Sign



[PS-1PTS]



[PS-1PTSD]



[PP-2PTS1]

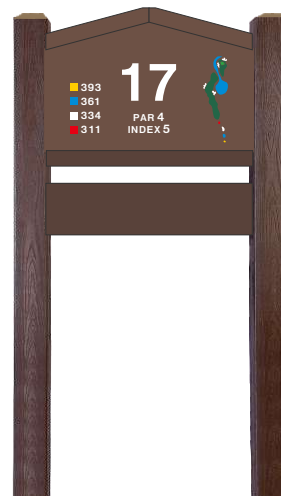

[PP-2PTS2]



[PP-2PTS3]



[PP-2PTS4]

COLORFUL PLASTIC FAIRWAY DISTANCE MARKERS

- Made from durable colorful plastic, virtually unbreakable and Extremely fade-resistant.
- 1" (2.5cm) thickness.
- Two stainless steel spikes screwed in the back to secure marker.
- Available colors: Red, White, Blue, yellow and Black.
- Custom size are available upon request.



ROUND DISTANCE MARKERS

6" (15cm) in diameter

Order Information:

- 25-RDM15R Red
- 25-RDM15W White
- 25-RDM15B Blue
- 25-RDM15Y Yellow
- 25-RDM15K Black

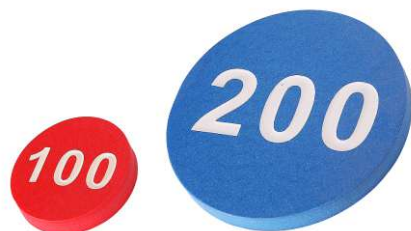

[25-DM15R]

[25-DM30B]

ROUND DISTANCE MARKERS

11.5" (29cm) in diameter

Order Information:

- 25-RDM30R Red
- 25-RDM30W White
- 25-RDM30B Blue
- 25-RDM30Y Yellow
- 25-RDM30K Black



[25-DM15Y]

RECTANGULAR DISTANCE MARKERS

12"*8" (30*20cm), engraved numbers

Order Information:

- 25-DM20R Red 100
- 25-DM20W White 150
- 25-DM20B Blue 200
- 25-DM20Y Yellow 250
- 25-DM20K Black (50 or other number)

CUSTOMIZED SPRINKLER HEAD TAGS

- Customized tags for your sprinkler head. For just a little more money your golfer will love it.
- 1 mm thick laminate or stainless tags fit into your sprinkler head well.
- Just send us your tag drawings and distance number, we will do all the rest for you.

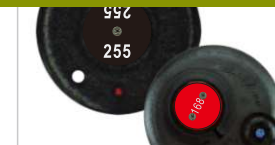

[SS-SHT]

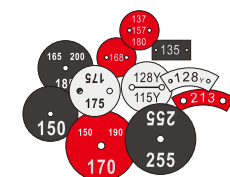

[LN-SHT]

STAINLESS STEEL TAGS

Order information:
SS-SHT Stainless Steel Tag

LAMINATE PLASTIC TAGS

Available colors: red tag with white number, black tag with white number, white tag with black number.

Order information:

- LN-SHTR Laminate Tag-red in white number
- LN-SHTB Laminate Tag-black in white number
- LN-SHTW Laminate Tag-white in black number

ALUMINIUM DISTANCE MARKERS

- 7-9/10" (20.0) cm diameter cast aluminium, powder coated with brushed aluminium number.
- Completed with stainless steel spike.

Order information:

- 32330 Aluminium Distance marker - 50
- 32331 Aluminium Distance marker - 100
- 32332 Aluminium Distance marker - 150
- 32333 Aluminium Distance marker - 200
- 32334 Aluminium Distance marker - 250



[32333]

DISTANCE POSTS

- Recycled plastic square post with wood grain surface, extremely long lasting.
- Supplied with engraved numbers on two sides, or with reverse-printed plates recessed into two side of post, suitable for your club logo, colors, text as required.
- Available colors: brown and black. Please specify color when ordering.



[80-DP81]

DISTANCE POST

Post dimension:
3.15"×3.15"×32" (8*8*81cm)
with two stainless steel spikes
Not available in black color.

Order information:

- 80-DP811** 81cm tall, Engraved-50
- 80-DP812** 81cm tall, Engraved-100
- 80-DP813** 81cm tall, Engraved-150
- 80-DP814** 81cm tall, Engraved-200
- 80-DP815** 81cm tall, Engraved-250
- 80-DP81C** Printed custom plate



[90-DP122C]

DISTANCE POST

Post Dimension: 3.5"×3.5"×32" (9*9*81cm) with two stainless steel spikes.
3.5"×3.5"×48" (9*9*122cm) without spike.

Order information:

- | | |
|---|---|
| 90-DP811 81cm tall, Engraved-50 | 90-DP1221 122cm tall, Engraved-50 |
| 90-DP812 81cm tall, Engraved-100 | 90-DP1222 122cm tall, Engraved-100 |
| 90-DP813 81cm tall, Engraved-150 | 90-DP1223 122cm tall, Engraved-150 |
| 90-DP814 81cm tall, Engraved-200 | 90-DP1224 122cm tall, Engraved-200 |
| 90-DP815 81cm tall, Engraved-250 | 90-DP1225 122cm tall, Engraved-250 |
| 90-DP81C Printed custom plate | 90-DP122C Printed custom plate |



PLASTIC YARDAGE MARKERS

Molded with UV-resistant color, 2" (5.0cm) diameter, 24" (61cm) long plus stainless steel spike. Colourful yardage number decals stuck on the top. Highly visible and virtually unbreakable. Ideal for designating yardage to the green.

Order information:

- 50-YM611** White/red -100 yard
- 50-YM612** White -150 yard
- 50-YM613** White/blue -200yard
- 50-YM614** White/Yellow -250yard



[50-YM61]



[50-DM61]

PLASTIC DISTANCE MARKER

Molded with UV-resistant colors, maintenance free, won't rot, crack. - 2" (5.0cm) diameter, 24" (61cm) long plus stainless steel spike.

Order information:

- 50-DM611** Plain Red
- 50-DM612** Plain White
- 50-DM613** Plain Blue
- 50-DM614** Plain Yellow

PVC DISTANCE MARKERS

- 4.0cm dia PVC tube 61 cm tall with caps and spike.
- Colorful yardage number decals stuck on the top.
- Highly visible, easy to remove and replace.

Order information:

- 32210** White/green 50 Decal
- 32211** White/red 100 Decal
- 32212** White 150 decal
- 32213** White/blue 200 Decal
- 32214** White/Yellow 250 Decal

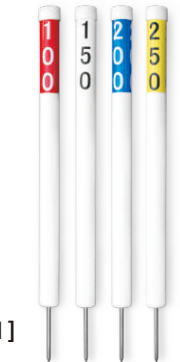

[32211]

COLORFUL PLASTIC DISTANCE POSTS

- Made from durable colorful recycled plastic, virtually unbreakable and Extremely fade-resistant.
- Engraved and poured or with strips.
- Two stainless steel spikes included for portable application.
- Available colors: Red, White, Blue, yellow and Black.
- Custom size are available upon request.



[50-RDM]

ROUND DISTANCE MARKERS

2" Dia. * 24" H (9.5 * 2.5 * 61 cm)
Black color is not available.

Order information:

- 50-RDM1 Red 100
- 50-RDM2 White 150
- 50-RDM3 Blue 200
- 50-RDM4 Yellow 250



[25-SDM]

SLAT DISTANCE MARKERS

3.75" * 1" * 28" H (9.5 * 2.5 * 71 cm)

Order information:

- 25-SDM1 Red 100
- 25-SDM1 White 150
- 25-SDM3 Blue 200
- 25-SDM4 Yellow 250
- 25-SDMH Hazard
- 25-SDMO OB
- 25-SDMK Keep out
- 25-SDMC Custom

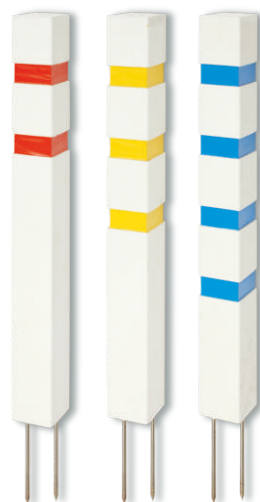

[75-WSP]

WHITE STRIPED POSTS

3" * 3" * 32" H (7.5 * 7.5 * 81 cm)

Order information:

- 75-WSP1 One Stripe
- 75-WSP2 Two Stripes
- 75-WSP3 Three Stripes
- 75-WSP4 Four Stripes

4" * 4" * 32" H (10 * 10 * 81 cm)

Order information:

- 100-WSP1 One Stripe
- 100-WSP2 Two Stripes
- 100-WSP3 Two Stripes
- 100-WSP4 Two Stripes



[100-CDP]

COLORFUL DISTANCE POSTS

4" * 4" * 32" H (10 * 10 * 81 cm)

Order information:

- 100-CDP1 Red 100
- 100-CDP2 White 150
- 100-CDP3 Blue 200
- 100-CDP4 Yellow 250
- 100-CDP5 Custom

OB & HAZARD MARKERS

- Made from durable colorful plastic, Colour-impregnated.
- Virtually unbreakable and Extremely fade-resistant.
- Available in red, white, blue and yellow.
- Stainless steel spike included.
- Custom size available upon request.

SQUARE OB AND HAZARD MARKER

1.5" square (4*4cm), pointed.

Ordering information:

- | | |
|-------------------------------------|-------------------------------------|
| 40-HMP611 24"(61cm) - Red | 40-HMP811 32"(81cm) - Red |
| 40-HMP612 24"(61cm) - White | 40-HMP812 32"(81cm) - White |
| 40-HMP613 24"(61cm) - Blue | 40-HMP813 32"(81cm) - Blue |
| 40-HMP614 24"(61cm) - Yellow | 40-HMP814 32"(81cm) - Yellow |

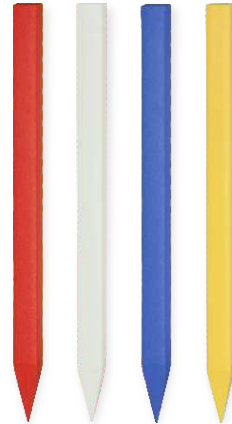

[40-HMP61]

PVC HAZARD MARKER

- These hazard markers come pre-applied with vinyl shrink-wrap covering to protect against fading, cracking, scratching and engineered for superior durability and visibility.
- 1-3/5"(4.0cm) diameter 24"(61cm) long with steel spike

Ordering information:

- 3225A** PVC hazard marker - Red
- 3225B** PVC hazard marker - Yellow
- 3225C** PVC hazard marker - White



[3225]

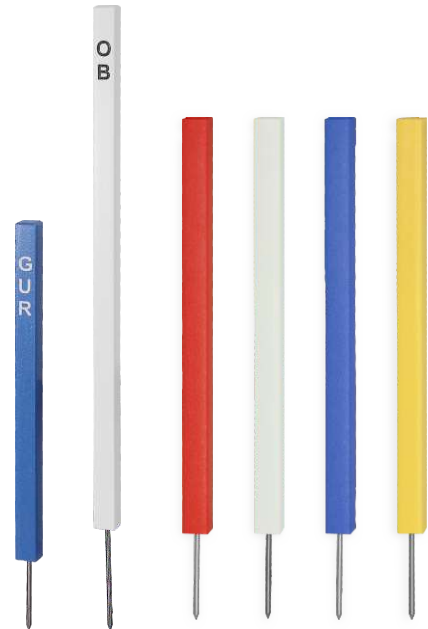

[40-HMS61]

SQUARE OB AND HAZARD MARKER

1.5" square (4*4cm), spiked.

Ordering information:

- | | |
|-------------------------------------|-------------------------------------|
| 40-HMS301 12"(30cm) - Red | 40-HMS611 24"(61cm) - Red |
| 40-HMS302 12"(30cm) - White | 40-HMS612 24"(61cm) - White |
| 40-HMS303 12"(30cm) - Blue | 40-HMS613 24"(61cm) - Blue |
| 40-HMS304 12"(30cm) - Yellow | 40-HMS614 24"(61cm) - Yellow |
| 40-HMS461 18"(46cm) - Red | 40-HMS811 32"(81cm) - Red |
| 40-HMS462 18"(46cm) - White | 40-HMS812 32"(81cm) - White |
| 40-HMS463 18"(46cm) - Blue | 40-HMS813 32"(81cm) - Blue |
| 40-HMS464 18"(46cm) - Yellow | 40-HMS814 32"(81cm) - Yellow |



[50-HMR61]

ROUND OB AND HAZARD MARKER

2" Dia. (5cm), spiked.

Ordering information:

- 50-HMS461** 18"(46cm) - Red
- 50-HMS462** 18"(46cm) - White
- 50-HMS463** 18"(46cm) - Blue
- 50-HMS464** 18"(46cm) - Yellow
- 50-HMS611** 24"(61cm) - Red
- 50-HMS612** 24"(61cm) - White
- 50-HMS613** 24"(61cm) - Blue
- 50-HMS614** 24"(61cm) - Yellow

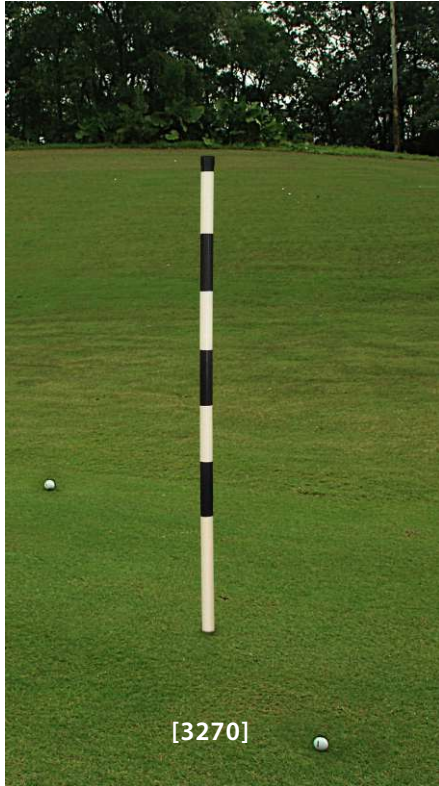

[3270]

FAIRWAY MARKING POLE

- 60" (152cm) long, 1-3/5" (4.0cm) diameter heavy-duty PVC pole pre-applied with vinyl-wrap covering for superior durability and visibility.
- Make to mark the center of the fairway, 150 yards, or other distances, or to indicate the edge of a hazard
- 10" (25cm), 2" (5.0cm) diameter ground anchor included.

Ordering information:

- 32700** Black & White stripe
- 32701** Red and White stripe



[32281]

ENVIRONMENTAL CAPS

- 4" (10.2cm) long vinyl cap to indicate environmental sensitive areas.
- Fit in 1-1/2" (3.8cm) square post
- Colors: Green, Black.

Ordering information:

- 32281** Environmental Cap - Green
- 32282** Environmental Cap - Black



DUAL-COLOUR MULTIPURPOSE MARKERS

- Durable multipurpose markers in two styles.
- 1/2" (3.8cm) square recycled plastic white stakes with 4" (10cm) green vinyl cap and sleeve.
- stainless steel spike included.
- These useful markers allow you to designate the desired usage in the way you like: To direct cart and foot traffic, to protect wet and new soil areas, or to circle a specific area on the ground

Ordering information:

- 3229** 2-Stripes Multipurpose Marks
- 3230** 4-Stripes Multipurpose Marks, 18" (46cm) long, 4 stripes
- 32291** 2-Stripes Multipurpose Marks in bucket (25pcs)



RECYCLED PLASTIC FENCING

A fence with gates is a great way to mark boundaries and add privacy on your golf Course facilities, while it also has decorative feature to add an artistic touch to your property.

- Produced with individual pieces of recycled plastic slats, customized styles. white or brown.
- Extremely durable, light weight, maintenance free, It won't rot or rust, Just wash it as needed, no need to paint or stain.
- Sold in fence panels, you just need to fit the fence panels together on site.
- Contact us to design your own fencing at any budget.

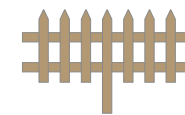

[90-FP9018]

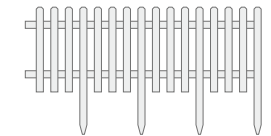

[65-FP6518]

Order information

Please specify color when ordering.

- 65-FP6518** Fence Panel (slat size: 65*18mm)
- 90-FP9018** Fence Panel (slat size: 90*18mm)

SQUARE ROPE STAKE

- 1-1/2"(4.0cm) square recycled plastic
- Angled slot designed for 1/4"(0.64cm) braided rope.
- Complete with stainless steel spike.
- Available colors: green, brown and black.
- Custom size also available upon request.

Order information:

40-RS301 12"(30cm) tall-green
40-RS302 12"(30cm) tall-brown
40-RS303 12"(30cm) tall-black

40-RS451 18"(45cm) tall-green
40-RS452 18"(45cm) tall-brown
40-RS453 18"(45cm) tall-black

40-RS601 24"(60cm) tall-green
40-RS602 24"(60cm) tall-brown
40-RS603 24"(60cm) tall-black



[40-RS60]

ROUND ROPE STAKE

- 2"(5cm) round recycled plastic.
- Angled slot designed for 1/4"(0.64cm) braided rope.
- Complete with stainless steel spike.
- Available color: white
- Custom size also available upon request.

Order information:

50-RS30 12"(30cm) tall
50-RS45 18"(45cm) tall
50-RS60 24"(60cm) tall



[50-RS45]

POLYTHENE BRAIDED ROPE

- 1/4"(0.65cm) diameter
- Each coil contains 1000ft(305m)
- Available in 4 colours

Order information:

3243A - Yellow
3243B - White/green
3243C - White
3243D - Green



[3243]

ROPE POSTS

- Made from recycled plastic .
- Complete with two stainless steel spikes base.
- Choose with hole or without hole.

Dimension: 4"*4"*10" (10*10*30cm)
 4"*4"*15.5" (10*10*40cm)

Available Colors: Black and White.
 Please specify color when ordering .

Order information:

100-RP30 Beveled Top 12"(30cm)
100-RP30G Beveled and Grooved Top 12"(30cm)
100-RP40 Beveled Top 15.5"(40cm) tall
100-RP40G Beveled and Grooved Top 15.5"(40cm)



[100-RP40G]

[100-RP40]

STEEL ROPE STAKE

- Total 38-3/5"(98cm) long.
- 1/4"(0.65cm) in diameter
- Galvanized finish
- Positions easily with foot pressure

Order information:

3242 Steel rope stake



[3242]

PLASTIC NTP/LONG DRIVE MARKERS

- Made of Green/white Laminated plastic with high transparent acrylic cover. Weather resistant.
- NTP marker unit may contain a built-in tape measure 10m(33ft) as required, allowing you to measure from ball-to-cup easily.
- stainless steel spike.
- Cards easily slide in and out from side window.
- 275mm H x 165mm W plus spike

Order information:

3910 NTP / Long Drive Marker

3910TM NTP marker with Tape Measure



[3910]

Back View Of 3910TM

PLASTIC NTP/LONG DRIVE MARKERS

- Made of recycled plastic with aluminium handle and high transparent acrylic cover. Weather resistant.
- NTP marker unit may contain a built-in tape measure 10m(33ft) as required, allowing you to measure from ball-to-cup easily.
- stainless steel spike.
- 28cm H x 17cm W plus spike

Order information:

3920 NTP / Long Drive Marker

3920TM NTP marker with Tape Measure



[3920]

STAINLESS STEEL LONG DRIVE / NTP MARKERS

Sturdy stainless steel frame that hold 4 cards. 15cmW x 20cmH plus spike

Order information:

32231 Long Drive/NTP marker1

32232 Long Drive/NTP marker2



[32231]

[32232]

NTP/LONG DRIVE CARD PACKS

25 pcs each pack, fit 3910, 3920 and 3223

Order information

32233N NTP cards (25pcs)

32233L Long Drive cards (25pcs)



[32233]

CUSTOM MARKER

If you don't see the signs you need on our catalog, we will customize one for you. Just tell us what you want or you can design your signs and let us do all the rest.

Ordering information:

CNTP Custom Marker



[01]



[02]



[03]



[04]

[CNTP]



[10L-AS5040]
A Frame Notice Sign 50*40cm



[HN-AT5060]
A Frame Tee Sign 50*60cm



[HN-EC4060]
Easel Sign-Clock 40*60cm



[HN-ER5080]
Easel Sign-Range 50*80cm



[3050]
Aluminium Base and post



[HN-EN60100]
Easel Sign-EN 60*100cm



[HS-ET5080]
Easel Sign-ET 50*80cm



[HS-EB5080]
Easel Sign-EB 50*80cm

FLAGS

We make and supply superior quality golf flags, crafted of 420 Denier high quality nylon material.

- All our flags are made by our in house professional flag makers with stronger stitching, including bar-tracked corners, double rows and zig-zag stitched or triple stitching on the fly hem, ensures durability in extreme wind conditions.
- Improved fade resistant colour to extend the life of a golf flag.
- Available in convenient tube-style and tie-style.
- Size (approx): 20"X13-1/2"(51cmX34cm)

Colors in stock:



Tube lock Flags



The flags are sewn to a molded one-piece plastic tube, simply slip over the flagstick and fasten with an acorn nut.



[33271]

FLAG TUBE

18mm inside diameter, strong and durable material.

Order information:
33271 Flag tube

Grommet-tie Flags



Tie style flags require swivels and ties for attachment to the flagstick.



[33272]

SWIVEL

Material: stainless steel rod and plastic claps.

Order information:
33272 Swivel



CUSTOM FLAGS

All our regulation flags can be customized with your logo or message. It can be either screen printed or embroidered, all you have to do is provided us with high quality artwork and our skillful staff will do the rest.

1. SCREEN PRINTED FLAGS



2. EMBROIDERED FLAGS



CHECKERED FLAGS



[3324]

Order information

- | | | |
|--|--|---|
| Red & White
3324A1 Tube-lock
3324A2 Grommet-tie | Golden & Black
3324B1 Tube-lock
3324B2 Grommet-tie | Blue & White
3324C1 Tube-lock
3324C2 Grommet-tie |
| Black & Yellow
3324D1 Tube-lock
3324D2 Grommet-tie | Black & White
3324E1 Tube-lock
3324E2 Grommet-tie | Green & White
3324F1 Tube-lock
3324F2 Grommet-tie |



[3320]

SOLID FLAGS

Order information

- Solid Red
3320A1 Tube-lock
3320A2 Grommet-tie
- Solid White
3320D1 Tube-lock
3320D2 Grommet-tie
- Solid Blue
3320C1 Tube-lock
3320C2 Grommet-tie
- Solid Yellow
3320B1 Tube-lock
3320B2 Grommet-tie
- Solid Gold
3320E1 Tube-lock
3320E2 Grommet-tie
- Solid Green
3320G1 Tube-lock
3320G2 Grommet-tie
- Solid Pink
3320H1 Tube-lock
3320H2 Grommet-tie
- Solid Black
3320F1 Tube-lock
3320F2 Grommet-tie



[3321]

NUMBERED FLAGS

Order information

- Red with white number
3321A1 Tube-lock 1-9
3321A2 Tube-lock 10-18
3321A3 Grommet-tie 1-9
3321A4 Grommet-tie 10-18
- Blue with white number
3321C1 Tube-lock 1-9
3321C2 Tube-lock 10-18
3321C3 Grommet-tie 1-9
3321C4 Grommet-tie 10-18
- Yellow with black number
3321B1 Tube-lock 1-9
3321B2 Tube-lock 10-18
3321B3 Grommet-tie 1-9
3321B4 Grommet-tie 10-18
- White with red number
3321D1 Tube-lock 1-9
3321D2 Tube-lock 10-18
3321D3 Grommet-tie 1-9
3321D4 Grommet-tie 10-18



[3322]



[3323]



TWO-TONE FLAGS

Order information:

- 3322AG** Red with hunter green tube
- 3322BF** Yellow with black tube
- 3322CF** Blue with black tube
- 3322DC** White with blue tube
- 3322AF** Red with black tube
- 3322BG** Yellow with hunter green tube
- 3322DG** White with hunter green tube
- 3322DA** White with red tube



BORDERED FLAGS

Order information

- 3323AG** Red with hunter green border
- 3323BF** Yellow with black border
- 3323BG** Yellow with hunter green border
- 3323DC** White with blue border
- 3323DF** White with black border
- 3323AF** Red with black border
- 3323CF** Blue with black border
- 3323DG** White with hunter green border
- 3323DA** White with red border

TOP STUDS



[3315C1]

- Aluminum
- Anodized Nature
- Aluminium Acorn Nut
- Thread Size: M8



[3315C2]

- Aluminum
- Anodized Black
- Plastic Acorn Nut
- Thread Size: M8



[3315C5]

- Aluminum
- Anodized Black
- Plastic Ball Nut 41mmDia.
- Thread Size: M8



[3315C6]

- Aluminum
- Anodized Black
- Plastic Acorn Nut
- Thread Size: 3/8"-24



[3315C7]

- Aluminum
- Anodized Gold
- Plastic Acorn Nut
- Thread Size: 3/8"-24

FERRULES



[3315A1]

- Cost Aluminum
- 27mm Dia.
- Anodized Black



[3315A2]

- Zinc Alloy
- 27mm Dia.
- Anodized Gold



[3315H]

- Zinc Alloy
- 27mm Dia.
- Anodized Nature



[3315B1]

- Aluminum
- 19mm Dia.
- Anodized Black



[3315B2]

- Aluminum
- 19mm Dia.
- Anodized Nature



[3328]

PLACEMENT FLAGS

5"X7-1/2"(13cmX19cm)

Order information:

- 3328A1 Plain Red
- 3328A2 Red flag white printing
- 3328B1 Plain Yellow
- 3328B2 Yellow flag black printing
- 3328C1 Plain Blue
- 3328C2 Blue flag white printing
- 3328D1 Plain White
- 3328D2 White flag red printing

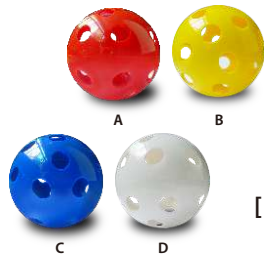

[3329]

PLACEMENT MARKERS

Fits 1/2"(12.7mm) flagstick only.

Order information:

- 3329A Placement marker-Red
- 3329B Placement marker-Yellow
- 3329C Placement marker-Blue
- 3329D Placement marker-White



[33291] [33292]

RUBBER GROMMETS

The rubber grommet can be used to hold the hole location indicator positioned on the flagstick.

Order information:

- 33291 Fits 1/2"Dia.(13mm) Flagstick
- 33292 Fits 3/4"Dia.(19mm) Flagstick



[3316]

BALL LIFTER

Made of flexible PU. Attach to the bottom of falgsticks, freely removes golf balls from the cup without damaging the hole.

Order information:

- 3316 Ball Lifer

FLAGSTICKS

PARSETT make and supply three kinds of flagsticks, they are:

- 1/2" (12.7mm) Regular flagsticks
- 3/4" (19mm) Tournament flagsticks
- 1" (25mm) Tournament flagsticks

All our flagstick come complete with ferrule and top stud, and we have series of flagstick parts with different features to meet your requirements and convention. Please let us know which ferrule or top stud you would like to use when ordering our flagsticks. Also custom flagstick parts is available upon your request.



All Regular Flagsticks are solid fiberglass construction, 1/2" (1.3cm) diameter from top to bottom, and come standard with **3315A1** ferrule and **3315C6** Top Stud unless otherwise specified.

Can be customized with other ferrules list below, a little extra charge for Zinc alloy ferrules.



- Cost Aluminum
- 27mm Dia
[3315A1]



- Aluminum
- Anodized Black
- Plastic Acorn Nut
- Thread Size: 3/8"-24
[3315C6]



[3315A2]
- Zinc Alloy
- 27mm Dia.
- Anodized Gold



[3315H]
- Zinc Alloy
- 27mm Dia.
- Anodized Nature



[3315B1]
- Aluminum
- 19mm Dia.
- Anodized Black

SOLID REGULAR

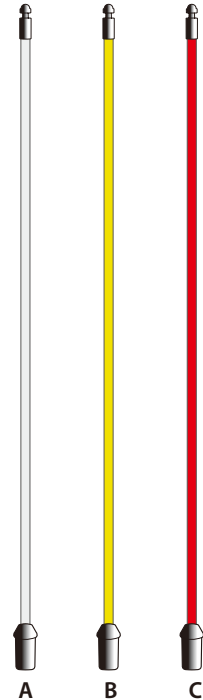

A B C

STRIPED REGULAR

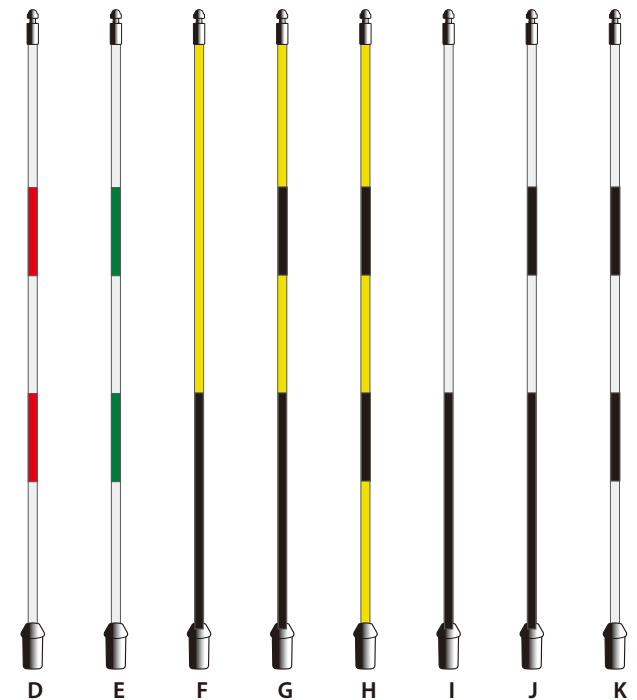

[3311]

SOLID REGULAR FIBERGLASS FLAGSTICKS

Fiberglass flagsticks, 1/2" (12.7mm) Dia. Color impregnated.

- | | | |
|--|---|--|
| <p>SOLID BRIGHT WHITE (A-TYPE)</p> <p>3311 A0 6'Tall</p> <p>3311 A1 7'Tall</p> <p>3311 A2 7.5'Tall</p> <p>3311 A3 8'Tall</p> <p>3311 A4 10'Tall</p> | <p>SOLID BRIGHT YELLOW (B-TYPE)</p> <p>3311 B0 6'Tall</p> <p>3311 B1 7'Tall</p> <p>3311 B2 7.5'Tall</p> <p>3311 B3 8'Tall</p> <p>3311 B4 10'Tall</p> | <p>SOLID BRIGHT RED (C-TYPE)</p> <p>3311 C0 6'Tall</p> <p>3311 C1 7'Tall</p> <p>3311 C2 7.5'Tall</p> <p>3311 C3 8'Tall</p> <p>3311 C4 10'Tall</p> |
|--|---|--|

STRIPED REGULAR FIBERGLASS FLAGSTICKS

Fiberglass flagsticks, 1/2" (12.7mm) Dia, Multitude of color and style

- | | | | |
|--|--|---|--|
| <p>WHITE/RED STRIPE (D-TYPE)</p> <p>3311 D1 7'Tall</p> <p>3311 D2 7.5'Tall</p> <p>3311 D3 8'Tall</p> | <p>WHITE/GREEN STRIPE (E-TYPE)</p> <p>3311 E1 7'Tall</p> <p>3311 E2 7.5'Tall</p> <p>3311 E3 8'Tall</p> | <p>YELLOW/30" BLACK BOTTOM (F-TYPE)</p> <p>3311 F1 7'Tall</p> <p>3311 F2 7.5'Tall</p> <p>3311 F3 8'Tall</p> | <p>YELLOW/BLACK BRITISH STRIPE (G-TYPE)</p> <p>3311 G1 7'Tall</p> <p>3311 G2 7.5'Tall</p> <p>3311 G3 8'Tall</p> |
| <p>YELLOW/BLACK STRIPE (H-TYPE)</p> <p>3311 H1 7'Tall</p> <p>3311 H2 7.5'Tall</p> <p>3311 H3 8'Tall</p> | <p>WHITE/30"BLACK BOTTOM (I-TYPE)</p> <p>3311 I1 7'Tall</p> <p>3311 I2 7.5'Tall</p> <p>3311 I3 8'Tall</p> | <p>WHITE/BLACK BRITISH STRIPE (J-TYPE)</p> <p>3311 J1 7'Tall</p> <p>3311 J2 7.5'Tall</p> <p>3311 J3 8'Tall</p> | <p>WHITE/BLACK STRIPE (K-TYPE)</p> <p>3311 K1 7'Tall</p> <p>3311 K2 7.5'Tall</p> <p>3311 K3 8'Tall</p> |

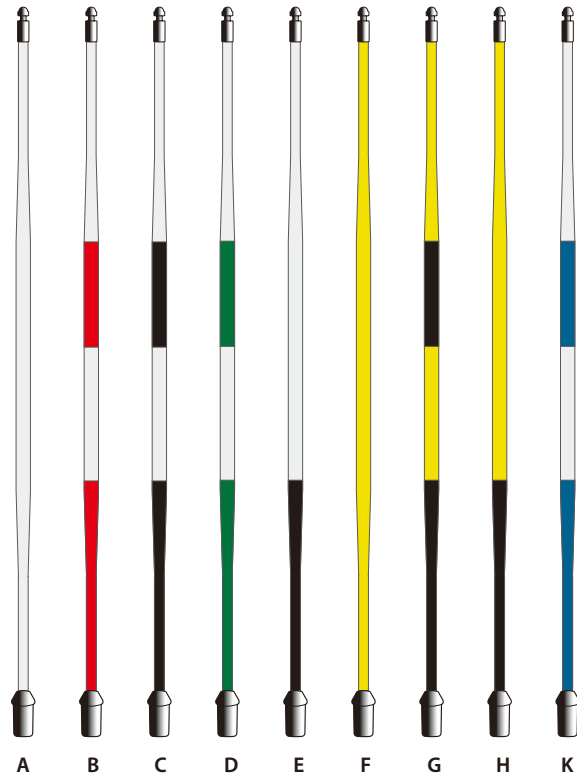

[3313]



- Cost Aluminum
- 27mm Dia
[3315A1]



- Aluminum
- Anodized Black
- Plastic Acorn Nut
- Thread Size: 3/8"-24
[3315C6]

All Tournament Flagsticks come standard with **3315A1** ferrule and **3315C6** Top Stud unless otherwise specified. Can be customized with other ferrules list below, a little extra charge for Zinc alloy ferrules.



[3315A2]

- Zinc Alloy
- 27mm Dia.
- Anodized Gold



[3315H]

- Zinc Alloy
- 27mm Dia.
- Anodized Nature

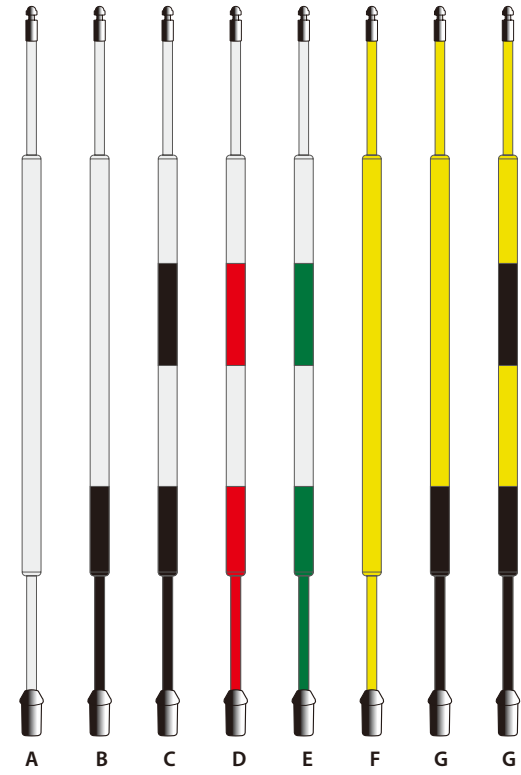

[3314]

TAPERED FIBERGLASS TOURNAMENT FLAGSTICKS

Javelin style flagsticks feature extra thickness in the center for increased strength, visibility and wind resistance.

1/2"(1.3cm)diameter at the top and bottom, 3/4"(2cm)diameter at the center.

Order information:	7' Tall	7.5' Tall		7' Tall	7.5' Tall
Solid White:	3313A1	3313A2	Solid Yellow:	3313F1	3313F2
White/Red British Stripe:	3313B1	3313B2	Yellow /Black British Stripe:	3313G1	3313G2
White/ Black British Stripe:	3313C1	3313C2	Yellow/30" Black Bottom:	3313H1	3313H2
White/Green British Stripe:	3313D1	3313D2	White/Blue British Strip:	3313K1	3313K2
White/30" Black Bottom:	3313E1	3313E2			

TOURNAMENT FLAGSTICKS

Standing tall and proud at 8' high, these tournament flagsticks feature an extra thick center section for increased strength, visibility and wind resistance.

Size:1/2"(1.3cm)diameter at the top and bottom, 1"(2.5cm)diameter at the center.

Order information:		
3314A	8' Solid White	3314E 8' White/Green British Stripe
3314B	8' White/ 30" Black Bottom	3314F 8' Solid Yellow
3314C	8' White/Black British Stripe	3314G 8' Yellow/30" Black Bottom
3314D	8' White/Red British Stripe	3314H 8' Yellow/Black British Stripe

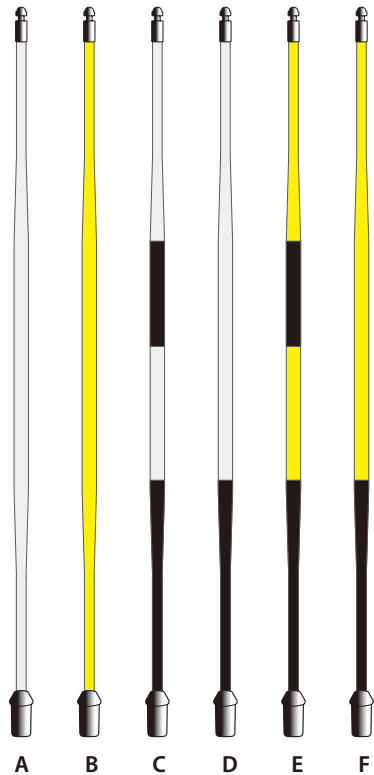

[3312]

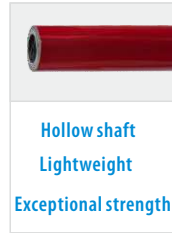

CARBON FIBER TOURNAMENT FLAGSTICKS

- Tapered hollow flagstick is reinforced with carbon fiber.
- Exceptional strength, stiff and lightweight.
- 1/2" (1.3cm) diameter at the top and bottom, 3/4" (2cm) diameter at the center.

Order information:

- | | |
|--|---|
| 3312A 8' Solid White | 3312D 8' White/30" Black Bottom |
| 3312B 8' Solid Yellow | 3312E 8' Yellow/Black British Stripe |
| 3312C 8' White/Black British Stripe | 3312F 8' Yellow/30" Black Bottom |

PRISM FLAGSTICKS

- For use with all distance rangefinders to give precise reading.
- Reflecting prisms are built directly into the body of the flagsticks, make it the most discreet reflector option.
- Prism flagsticks are available in 1/2" and 3/4" tapered shafts.
- Colors not shown above are also available upon request

TOURNAMENT PRISM FLAGSTICKS

3/4" Solid Tapered Fiberglass Flagsticks.

Order Information:

- 3313RA** 7.5' Bright White
- 3313RB** 7.5' Bright Yellow
- 3313RC** 7.5' White/Black British Stripe

TOUR PRISM FLAGSTICKS

1/2" Solid Fiberglass Flagsticks.

Order Information:

- 3311RA** 7.5' Bright White
- 3311RB** 7.5' Bright Yellow
- 3311RC** 7.5' White/Black British Stripe

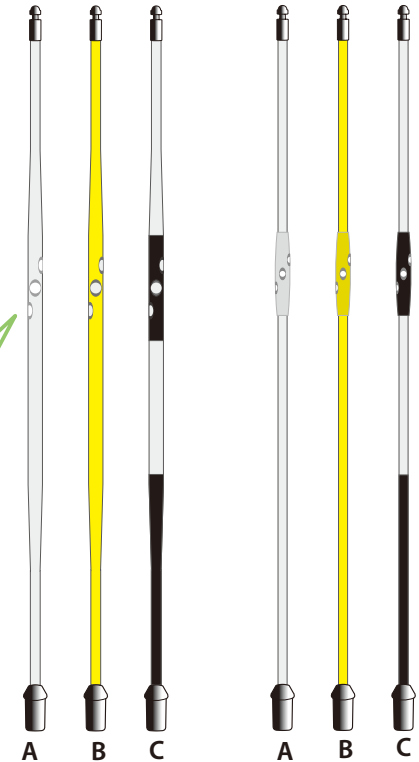
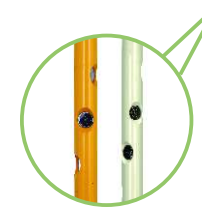

[3313R]

[3311R]



[3315E]

AimPin REFLECTORS

- Screws directly on the top of existing flagsticks in place of acorn nut with 3/8"-24 threaded or M8 threaded tips.
- Features Nylon threads, no brass insert prevents seizing to the top of the flagsticks.
- New six-prisms pod design, 100% reflection coverage, leaving no dead spots.

Order Information:

- 3315E** AimPin Reflector, Thread size: 3/8"–24
- 3315M** AimPin Reflector, Thread size: M8



ALUMINIUM GREEN CUP

- It's die cast in precision dimensions, 6 support pads on the bottom of the cup that eliminate sinking to maintain a stable height.
- Surface anodized and vertical surfaces are powder coated bright white.
- 6"HX4-1/4"Dia. (15cm X 10.8cmDia.)

Order information: (Fit ferrule size:27mm)

- 3348** Aluminum Green Cup
- 3348P** Aluminum Green Cup-Pink



[3348]



[3348P]

STAINLESS STEEL GREEN CUP

These cups are made from stainless steel material, can be rust resistant and virtually unbreakable.
6"HX4-1/4"Dia.(15cm X 10.8cmDia)

Order information:

- 33301** Stainless steel cup (Fit ferrule size: 27mm)
- 33302** Stainless steel cup (Fit ferrule size: 19mm)

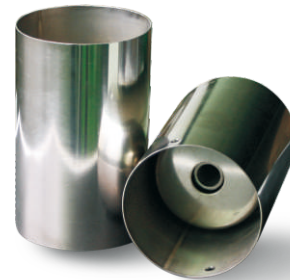

[3330]

COPPER BELL GREEN CUP

This cup has a copper bell inside the cup giving a pleasing sound as the golf ball drops into the hole.
6-7/10"HX4-1/4"Dia.(17cm X 10.8cmDia.)

Order information:

- 33311** Copper Bell Green Cup (Fit ferrule size:19mm)
- 33312** Copper Bell Green Cup (Fit ferrule size:27mm)



[3331]

EZ-WHITE CUP

- Ensure your holes remain perfectly white forever with our EZ-White Cup.
- Easily replaceable bright liner stays tight in the cup.
- The liner can easily be changed on a weekly basis or for special events.
- Your name or logo can also be added for your corporate events.

EZ-WHITE ALUMINIUM CUP

- Surfaces Anodized black aluminium cup plus bright white plastic liner, No paint to chip.
- 6"HX4-1/4"Dia. (15cm X 10.8cmDia.)

Order information: (Fit ferrule size:27mm)

- 3300** EZ-white Aluminium Cup
- 33001** EZ-white Cup Replacement Liner

[3300]

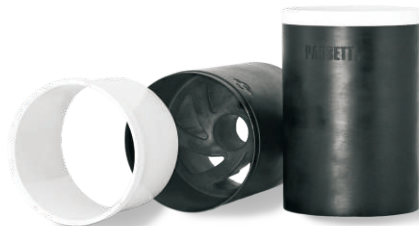

EZ-WHITE STAINLESS STEEL CUP

- Unique anti-rotational splines fitted together with our notched ferrule, preventing rotation and excessive wear.
- 6.5"HX4-1/4"Dia. (17cm X 10.8cmDia.)

Order information: (Fit ferrule size:2.7cm)

- 33053** EZ-white Stainless Steel Cup
Fit ferrule size:2.7cm
- 33052** EZ-white Stainless Steel Cup
Fit ferrule size:1.9cm
- 33051** EZ-white Cup Replacement

[3305]





TIO HOLE CUTTER PATENTED

Our new TIO Hole Cutter is created to come out with two great accomplishments:
 To cut an exact hole every time with an integral hammer action.
 To make hole cutting easy with the unique effortless plug ejection system.

ADVANTAGES:

- Pound-in hole cutting ensure perfect round hole with clean edges.
- labor-saving ratchet mechanism make plug ejecting easily.
- Auto locking handle system, balanced to carry straight after cutting.
- Built-in bubble level to ensure every hole is cut level.
- Vertical cut, no twisting required.
- Single-cut hole, Less cutting time.
- Optional adjustable Depth Stop Ring, bolts into place for Uniform hole depth.
- Optional Hole Cutter Stand, protects your greens from sharp edges and keep the hole cutter upright on the green.
- Whole unit weighs 9.3Kg, easy for anyone to operate.

It also comes with easy interchangeable inside sharpened or outside sharpened blades .

- Outside sharpened blade:** for heavier soil green
- Inside sharpened blade:** for lighter soil green

Order information:

- 33801** TIO Hole Cutter with Inside Sharpened Blade
- 33802** TIO Hole Cutter with Outside Sharpened Blade

HOLE CUTTER BLADES

Made using oversize alloy steel tube, then machine the inside and outside surfaces to accurate dimension that minimize ovality in the blade.
 Scalloped or straight blade for your choice.

Order information:

- 33433** Straight blade, inside edge
- 33434** Straight blade, outside edge

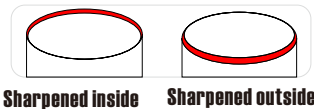

[33801]



[33433]



[33434]

DEPTH STOP RING

PATENT PENDING

- Made of maintenance free stainless steel.
- The stop ring can be adjusted in steps that enable any user to consistently cut correct depth each time.
- Just add the Depth Gauge to the blade, adjusts and bolts the stop ring to correct height.

Order information:

3346 Depth Stop Ring



[3346]



HOLE CUTTER STAND

- Made of maintenance free recycled plastic.
- Keep your hole cutter upright everywhere, whether on the green, on the transport vehicle, or on your workshop floor.
- Protects not only the blade, but also the green from sharp edges.
- Light weight and with spring sockets, it can be easily loaded on the blade.
- Can be bolted in position as a docking station for transporting or storage.

Order information:

MS-HCS Hole Cutter Stand



[MS-HCS]



HOLE CUTTER

Made chiefly of carbon steel, powder coated. Heat treated hardened steel blades are also dip-treated for corrosion resistance.

Order information:

- 33411** Lever Action Hole Cutter with Scalloped blade, inside edge.
- 33412** Lever Action Hole Cutter with Scalloped blade, outside edge.
- 33413** Lever Action Hole Cutter with Straight blade, inside edge.
- 33414** Lever Action Hole Cutter with Straight blade, outside edge.
- 33421** Foot Action Hole Cutter with Scalloped blade, inside edge.
- 33422** Foot Action Hole Cutter with Scalloped blade, outside edge.
- 33423** Foot Action Hole Cutter with Straight blade, inside edge.
- 33424** Foot Action Hole Cutter with Straight blade, outside edge.

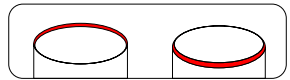

Sharpened inside Sharpened outside



[33433] [33434] [33431]

HOLE CUTTER BLADES

Made using oversize alloy steel tube, then machine inside and outside surfaces to accurate dimension that minimize ovality in the blade. Scalloped or straight blade for your choice.

Order information:

- 33431** Scalloped blade, inside edge
- 33432** Scalloped blade, outside edge
- 33433** Straight blade, inside edge
- 33434** Straight blade, outside edge



[3341] [3342]

ALUMINIUM DEPTH GAUGE

This gauge ensures consistent hole depth every time and attaches to any hole cutters.

Order information:
3344 Depth Gauge



[3344]

PLASTIC DEPTH GAUGE

- Made of maintenance free recycled plastic, strong and light weight.
- Single-set screw tightening.
- Fit all hole cutters.

Order information:
P-DG Plastic Depth Gauge



[P-DG]

GREENKEEPER CADDY

Green tools and mix carrying bag, includes inside a soft removable soil bucket.

Order information:

3351 Greenkeeper Caddy



[3351]

CUTTER GUIDE

Made of strongest plastic. Place the guide on the green and stand with both feet on the guide when cutting holes to eliminate heel marks and raised hole edges.

Order information:
3345 Cutter Guide



[3345]

HOLE CUTTER SHARPENER

For clean, sharp hole edges in your green, please give your hole cutter blade a few passes everyday with this handy tool to keep scalloped or straight cutter blade sharp. Easy to use and very economical.

Order information:

3347 Hole Cutter Sharpener



[3347]

GREEN SPEEDMETER

Our NEW Green Speedmeter is an extruded aluminum bar, 36 inches long, with a V-shaped groove on each side that extends along its entire length. It has two precisely milled ball-release notches, one on each side of the bar.

The first is the standard ball-release notch positioned approximately 30 inches from the tapered end that rests on the ground. This is the full-length run and should be used whenever possible.

On the reverse side is an alternate notch, located nearly 14 inches from the tapered end. The latter is the half length run and should only be used as an acceptable substitute when no full-length run is available.

Each end of the Green Speedmeter is tapered to reduce bounce as a rolling ball makes contact with the green.

Order information:
3250 Green Speedmeter

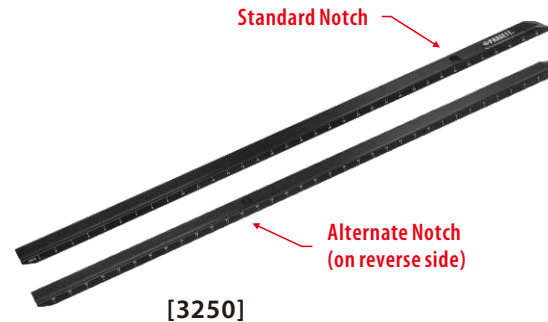

ALUMINIUM CUP SETTER

Heavy duty cast aluminium design, powder coated green. Used to seats cup to correct depth and flattens down cup hole edges.

Order information:
3334 Aluminum cup setter



CUP PULLERS

Three-hook cup puller: Made of stainless steel, pulls cup out of hole straight, easy pull with no damage to the turf.
 Two-hook cup puller: Made of stainless steel. Pulls cup out from ferrule hole.

Order information:
33371 Three-hook cup puller
33372 Two-hook cup puller



TARGET RING

Made of plastic. Bright white color to highlight area above cup.
 Sold in sets of 18

Order information:
3336 Target Ring



CURVED TRIMMING SCISSORS

Stainless steel, cup hole trimming scissors. The curved design makes trimming around a cup hole easy and accurate.

Order information:
3350 Curved Trimming Scissors



PLSTIC CUP COVER

Used for low play period or when top dressing. It's made of recycled plastic, fit any regulation cup and will not damage mowers.
 Size: 4 1/4" Dia.X1"H(10.6cmDia X 2.5cmH)

Order information:
3339 Rubber Cup Cover



PUTTING CUP REDUCER

Made of Bright white plastic, a set of two parts to decrease the size of the hole in two different levels.

Order information:
3340 Putting Cup Reducer



STEEL FIXTURE

This device is used to accurately paint the area above the green cups.

Order information:
3335 Steel fixture



CURVFORM RAKES

With its curved shape and short teeth, this rake effortlessly smooths sand back into perfect playing conditions. Made from sturdy plastic.

Head length: 15"(38cm)

Handles: Aluminium handle 54"(137cm),
or Aluminium handle 64"(163cm) bended,
or Fiberglass handle 54"(137cm).

Handel Color: Green

Ordering information:

32110 Curvform Rake Head only

32111 Curvform Rake Head with **32101** Handle

32112 Curvform Rake Head with **32102** Handle

32115 Curvform Rake Head with **32105** Handle

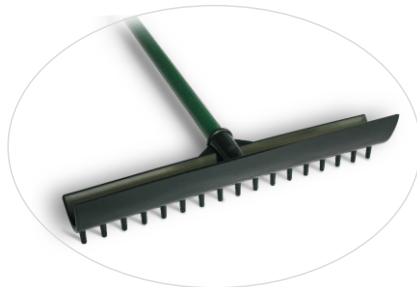

[3211]



COMBTEETH RAKES

Sturdy solid plastic head feature long teeth.

Head Length: 14"(36cm)

Handle: Aluminium handle 54"(137cm),
or Fiberglass handle 54"(137cm).

Handle color: green

Ordering information:

32120 Combteeth Rake Head only

32121 Combteeth Rake Head with **32101** Handle

32122 Combteeth Rake Head with **32102** Handle



[3212]

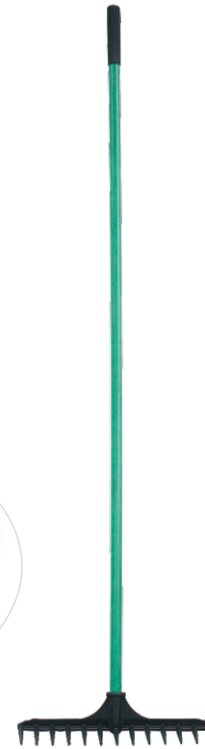

CART RAKES

Sturdy solid plastic head feature long teeth.

Head Length: 14"(36cm)

Handle: 48"(120cm)Aluminum handle without grip.

Handle color: green

Ordering information:

32126 Combteeth Rake Head
with **32106** Handle



[32126]



HANDLES

Full size of aluminium and fiberglass handles for your selection.

1. The aluminium handles is powder coated, will not fade or chip.
2. The filament woven fiberglass handle is quite different from the normal pultruded fiberglass. They are lighter and never splinter.
3. Colour: green

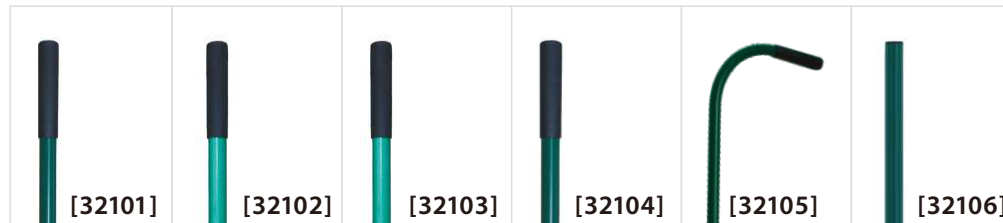

Order information:

32101 Aluminium handle with grip 54"(137cm)

32102 Fiberglass handle with grip 54"(137cm)

32103 Fiberglass handle with grip 72"(183cm)

32104 Aluminium handle with grip 96"(244cm)

32105 Bended aluminium handle with grip 64"(163cm)

32106 Aluminium handle without grip 48"(120cm)

TUBELIKE RAKE I

With its new design, ultra-lightweight and short teeth, this rake can greatly reduce furrows, leaving bunkers more consistent and smooth. Made from sturdy plastic. Head Length: 17"(43cm)
 Handles: Aluminium handle 54"(137 cm), or fiberglass handle 54"(137 cm) or aluminium bended handle 64"(163 cm),
 Handle color: green

Ordering information:

- 32180** Tubelike Rake I Head only
- 32181** Tubelike Rake I Head with **32101** Handle
- 32182** Tubelike Rake I Head with **32102** Handle
- 32185** Tubelike Rake I Head with **32105** Handle

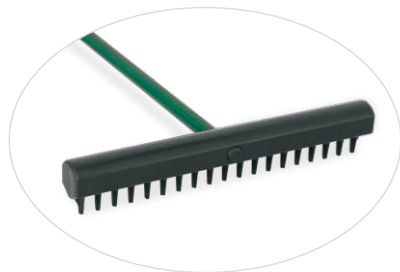

[3218]

TUBELIKE RAKE II

The same construction as Tubelike Rake I. Head Length: 25"(63cm)
 Handles: Aluminium handle 54"(137 cm) or fiberglass handle 54"(137 cm) or fiberglass handle 72"(183cm) or aluminium bended handle 64"(163cm)
 Handle color: green

Ordering information:

- 32190** Tubelike Rake II Head only
- 32191** Tubelike Rake II Head with **32101** Handle
- 32192** Tubelike Rake II Head with **32102** Handle
- 32193** Tubelike Rake II Head with **32103** Handle
- 32195** Tubelike Rake II Head with **32105** Handle



[3219]

LONG HANDLE RAKE

96"(244cm) long handle, coupled with a 25"(63cm) tubelike Rake head II, is perfect for large, deep face bunker. Now, you can easily rake your bunker by standing on the edges of bunker.

Head Length: 25"(63cm)
 Handle: Aluminium handle 96"(244cm)
 Handle color: green

Ordering information:

- 32194** Long Handle Rake

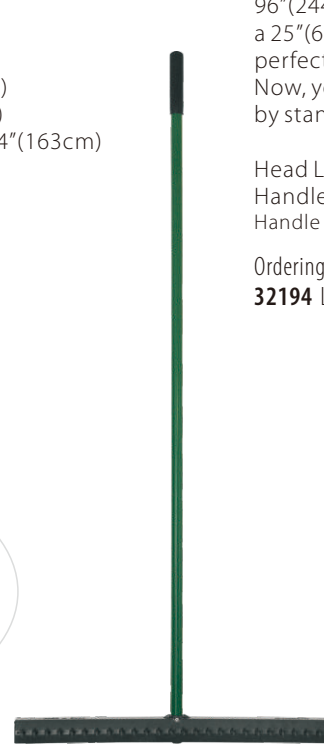

[32194]

HANDLES

Full size of aluminium and fiberglass handles for your selection.

1. The aluminium handles is powder coated, will not fade or chip.
2. The filament woven fiberglass handle is quite different from the normal pultruded fiberglass. They are lighter and never splinter.
3. Colour: green



Order information:

- 32101** Aluminium handle with grip 54"(137cm)
- 32102** Fiberglass handle with grip 54"(137cm)
- 32103** Fiberglass handle with grip 72"(183cm)
- 32104** Aluminium handle with grip 96"(244cm)
- 32105** Bended aluminium handle with grip 64"(163cm)
- 32106** Aluminium handle without grip 48"(120cm)



[3279]

SAFETY NET

- 6.5×6.5”(2m×2m) heavy-duty polyethylene net with yellow border.
- Two aluminium poles with stakes keep the net upright.
- Collapsible frame design, so it is easy to pack everything in one package.
- Two stakes included to Keep the net upright.

Order information:
3279 Safety Net



[3258]

DEW-WHIPPER

Two piece design, aluminium handle and fiberglass extension rod.
 Handle length” 7-7/8” (240cm)
 Extended length: 15-3/5”(475cm)
 Extended length: 15-3/5”(475cm)

Order information:
3258 Dew-Whipper

FOLDABLE DEW BRUSH

Designed for fast removal of dew from green.
 Total 10ft (300cm) width nylon brush in two halves fixed in strong aluminium bracing bracket. Aluminium handle in 72” (183cm) long. Easy folding and light weight.

Order information:
3259 Foldable Dew Brush



Folded for easy carrying and storage.

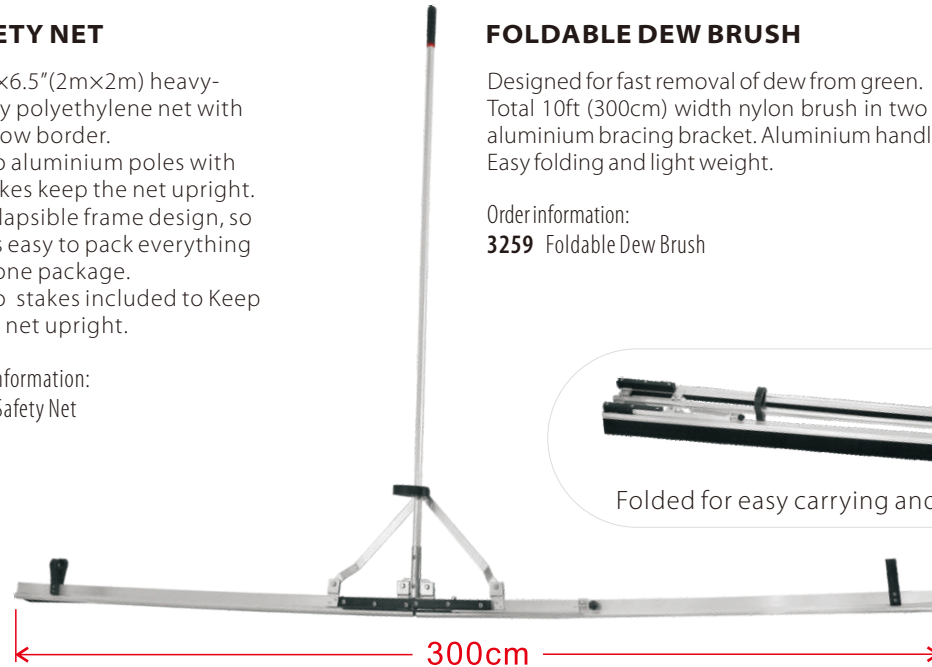

[3259]

MEASURING WHEEL

This handy device allows the accurate measurement of distance across all types of surfaces. Counter reads up to 10,000meters.It is made of precision steel with a folded handle grip and a plastic measuring wheel.

Order information:
3245 Measuring Wheel



[3245]

DRAG BRUSHES

Gently and evenly spreads dressing material over the green and also helps control thatch when used before mowing. Brush extensions provide a larger sweep area and are hinged to float over uneven areas. They come with weight racks to reduce vibrations and help follow undulations.

Order information:

- 3246** Drag Brush, 108"X26" (274cmX66cm)
- 32461** Drag Brush without the extension, 54-1/2"X26" (138cmX66cm)
- 32462** Two Extension section, 27"X26" (68.5cmX66cm) each



DRAG MATS

Used to spread dressing material over the green and for the shaping of fairways. The metal net can be fully electro galvanized or stainless steel material to resist rust. Custom sizes also available.

Order information:

- 32551** Galvanized steel Drag Mat 36"X60" (91.5cmX152.5cm)
- 32553** Galvanized steel Drag Mat 60"X84" (152.4cmX213.4cm)
- 32554** Stainless steel Drag Mat 36"X60" (91.5cmX152.5cm)
- 32556** Stainless steel Drag Mat 60"X84" (152.4cmX213.4cm)



LEVELAWNS

The levelawn effortlessly distributes application materials, removes stones from soil, breaks up small clods of sand or loam and smooths soil for planting. Stainless steel head available in two size : 30"(76cm) Wide, and 48"(122cm) wide. Three-section stainless steel handle with rubber grip.

Order information:

- 32471** 30" Head Levelawn
- 32472** 48" Head Levelawn

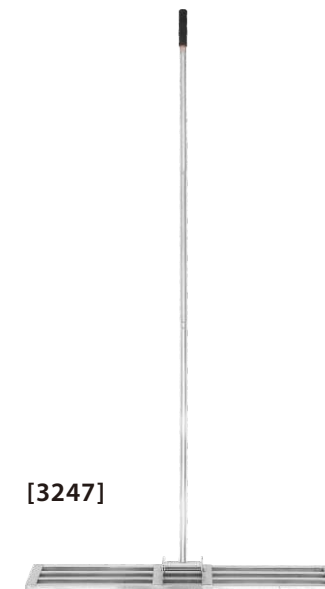

HAND OPERATED BRUSH

Easily be used to mow the places which dragon brush hard to reach. Durable brush head with aluminium handle or fiberglass handle. Size: 27"Wx54"L(69cmWX137cmL)

Order information:

- 3254** Hand Operated Brush aluminium handle



TURF PLUGGER

Ideal for replacing worn, damaged areas with healthy turf. Tube handle can hold up the plugs thus eliminating the need for clean up. Simply replace damaged plug with healthy plug from the top of the tube. 31-1/2" (80cm) tall Stainless Steel tube. Replaceable cutter blade made from case hardened steel. Plug measures: 2-1/6"(6cm)Dia X2-3/5"(7cm)deep.

Order information:
3256 Turf Plugger



[3256]

[3252]

TURF REPAIRER

This turf repairer can be used to cut hexagonal plugs of turf for easy removal and replacement.

Order information:
3252 Turf Repairer

SEVENTINES HAND OPERATED AERATOR

This aerator can be easily used to aerate small areas where compaction may have occurred or for aiding water percolation. Seven hollow or solid tines at 5cm spacing. A core collection is included. Tine size: 3/8"Dia.X3"(1cmDia.X8cm)

Order information:
32511H Seven Hollow Tines Hand Operated Aerator
32511S Seven Solid Tines Hand Operated Aerator



[32511]

[32512]

THREE TINES HAND OPERATED AERATOR

If the ground is too hard for seven tines to penetrate, there is provision for three to be used at 10cm spacing. Tine size: 2/5"Dia.X4-3/5"(1cmDia.X12cm)

Order information:
32512 Three Tines Hand Operated Aerator

SOIL SAMPLER

This unique designed soil sampler allows you to sample root growth beneath the surface. It is made from stainless steel pipe with a rubber grip. 7/8"(2cm)Dia.X19-5/8"(50cm)Length

Order information:
3249 Soil Sampler



[3249]

[3257]

SOIL PROFILE SAMPLER

Slicing a sample 6"long by 3" wide and 3/5" thick, this tools jaws are hinged at the top for easy opening and inspection. Sample can be easily redeposited by keeping one side open and replacing in hole.

Order information:
3257 Soil profile sampler



[32912]

ROLLER SQUEEGEE

Idea for removing water from greens and turf. Efficient, non-absorbent squeegee features a heavy-duty stainlesssteel frame. 36"(91cm)head with 56"(143cm) aluminium handle.

Order information:
32912 Roller Squeegee



[32172]

PLUG RAKE

31-1/2"(80cm) long aluminium head and 72"(183cm) handle. Light weight but durable and highly effective. Ideal for screening sand or top dressing or for collecting and removing coring plugs.

Order information:
32172 Plug rake



[32872]

LANDSCAPE RAKE

Long rounded teeth and striking edge excellent for construction and grading. 36" (91cm) Landscape Rake with 66" (1.7m) aluminium handle.

Order information:
32872 Landscape rake



[32171]

MAINTENANCE RAKE

18 teeth 24"(61cm) long aluminium head and 72"(183cm) handle, ideal for construction and repair work.

Order information:
32171 Maintenance rake



[3290]

CIRCULAR HEAD CUTTER

This efficient tool is ideal for cutting around sprinkler heads, distance markers and drains. Two pieces (handle + head) construction, one handle works with variety of head sizes. Interchangeable heads are available in 5" to 11" diameters.

Order information:
32900 Handle only **32908** 8" Head only
32905 5" Head only **32909** 9" Head only
32906 6" Head only **32910** 10" Head only
32907 7" Head only **32911** 11" Head only



ALUMINIUM SCOOP SHOVEL

These high quality aluminium shovels have specially tempered blades with straight cutting edges. thick-waled fiberglass handles with vinyl grips, or with poly D-grips. Scoop size: 15"X20"(38cm x 50.8cm)

Order information:
3261 Aluminium scoop shovel with Vinyl grip
3262 Aluminium scoop shovel with poly D-grip



[3262]



[3261]



[3248]

LEAF RAKE

Heavy duty spring action, 22 style teeth, and wooden handle.

Order information:
3248 Leaf rake



[3441]

CADDY HEAD COVERS



[3446]

CADDY SUITS



[SB-02]



[SB-03]



[SB-04]



[SB-05]



[3538]

SCORE CARD HOLDERS



[SB-06]



[SB-07]



[SB-08]



[SB-09]

SAND BAGS



[36411]

[36412]

BAG RAINCOVERS



[3450]

UMBRELLAS



[3442]

CADDY BIBS



[3531]



[3532]



[3533]

PENCILS

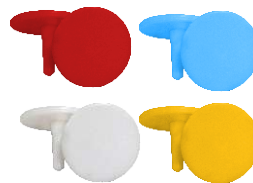

[3511]

PLASTIC BALL MARKERS

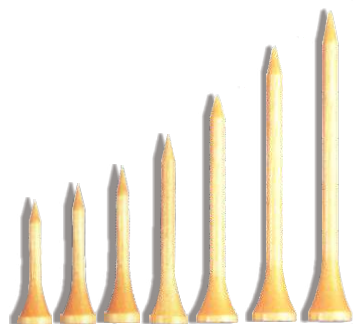

[3501]

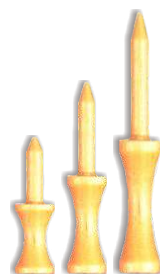

[3502]

WOODEN TEES



IMPRINTED WOODEN TEES

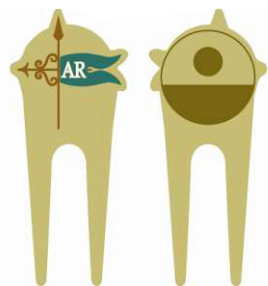

CUSTOMIZED METAL



[3510]

PLASTIC DIVOT TOOLS









[3510M1] [3510M2]

METAL DIVOT TOOLS





			
<p>MINI PICKERS Use this hand-operated picker for those hard to reach areas or</p>	<p>TARGET NETS Powder coated steel frame with PE netting sewn to the frame.....</p>	<p>RANGE BANNERS New and improved high quality nylon material makes</p>	<p>RANGE BALL WASHER Our new improved range ball washer that is redesigned and innovated</p>

[Home](#) > [New Products](#)

 <p>LOTUS BALL WASHER</p>	 <p>BALL WASHER CONSOLE UNITS</p>
 <p>RECYCLED PLASTIC POST TEE SIGNS</p>	 <p>INTERCHANGEABLE COURSE SIGNS</p>
 <p>5-Bag Rack</p>	 <p>TRASH CONTAINER/DIVOT MIX BOX COMBINATIONS</p>

	
<p>BAG TAG Bag tags can be made of various material including PVC,leather.....</p>	<p>IMPRINTED WOODEN TEES These premium golf tees are imprinted with your message</p>

[Home](#) > [Golf Accessories](#)

 <p>BAG TAGS</p>	 <p>DIVOT TOOLS</p>	 <p>WOODEN</p>
 <p>GOLF UMBRELLAS</p>		

PARSETT GOLF PRODUCTS CO.,LTD. COPYRIGHT©2012



Professional Supplier In Golf Industry

<p>DRIVING RANGE SUPPLIES</p> 	<p>GOLF COURSE SUPPLIES</p> 	<p>GOLF ACCESSORIES</p> 
---	---	---

	<p>DRIVING RANGE AND GOLF COURSE SUPPLIES CATALOGUE 2012 Click to DOWNLOAD</p>		<p>CEM Business For More Golf Products www.chinagolf.cn</p>
--	---	--	---

PARSETT GOLF PRODUCTS CO.,LTD. COPYRIGHT©2012

[PENCILS & SCORECARD HOLDERS](#)
[GOLF UMBRELLAS](#)

REPRESENTATIVE/DISTRIBUTOR

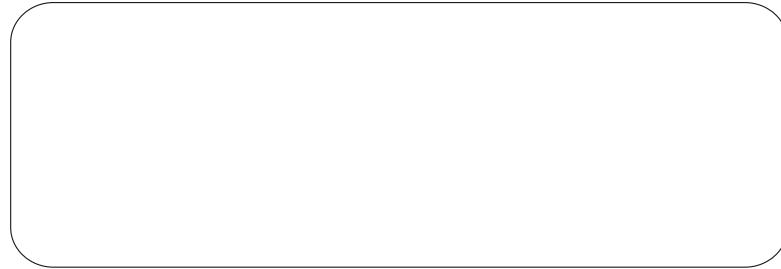

ZHUHAI PARSETT GOLF PRODUCTS COMPANY LIMITED

Building 1, Industrial Road No.12, Jishan Village,
Tangjiawan Town ,High-tech zone , Zhuhai City -519080,
Guangdong Province, China

Email: info@parsett.com sales@parsett.com

Website: www.parsett.com

